

INSTALLATION & OWNER'S MANUAL

ALL IN ONE Type Air-source Heat Pump Water Heater

Thank you very much for purchasing our product,
Before using your unit, please read this manual carefully and keep it for future reference.



WARNING

This unit is required reliable earthing before usage, may otherwise result in death or injury.

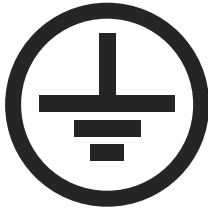

If you can't make sure that your house power supply is earthed well, please don't install the unit.

The unit must be installed by a licensed tradesperson and in accordance with:

- Midea installation instructions.
- AS/NZS 3500.4-"National Plumbing and Drainage Code Hot Water Supply Systems-Acceptable Solutions".
- AS/NZS 3000-Wiring Rules.
- Local authority regulations.
- Building Codes of Australia
- Local Occupational Health and Safety (OH&S) Regulations.

NOTICE TO CUSTOMERS

This water heater must be installed by a licensed person as required by the Building Act. Only a licensed person will give you a compliance certificate, showing that the work complies with all the relevant standards and only a licensed person will have insurance protecting their workmanship for 6 years.

Please read and understand this booklet. If you have any questions, please contact our service representative on 1300 367 565.

HOT WATER CAN BE DANGEROUS

Warning – Hot water burns. As a safety precaution, young children should always be supervised around hot water fixtures.

Heat pump water heaters can store water at temperatures that can cause scalding. Water temperatures over 50°C can scald and care needs to be taken to ensure that injuries do not occur through incorrect use of your water heater.

As heat pump water heaters can generate water temperatures in excess of 60°C, regulations require that a tempering valve be fitted to the heater to prevent water temperatures going to the home exceeding a preset safe maximum. The tempering valve must be connected to the hot water outlet line from the water heater. The valve must be fitted by an authorized plumber at the time of installation or in retrofitting to existing systems.

Care should be taken to avoid coming into contact with any pipe work or fixtures associated with the water heater pipe lines. **Under NO circumstances should any 'home handy man' type modifications be attempted.**

- This appliance is not intended for use by persons (including children) with reduced physical sensory or mental capabilities, or lack of experience and knowledge, that prevents them from using the appliance safely without supervision or instruction. Children should be supervised by a responsible person for their safety to ensure that they do not play with the appliance.
- **DANGER:** Failure to operate the relief valve easing gear at least once every six months may result in the water heater exploding. Continuous leakage of water from the valve may indicate a problem with the water heater.
- **THE INSTALLATION MUST COMPLY WITH THE REQUIREMENTS OF AS/NZS 3500.4, AS/NZS 3000, and all local codes and regulatory authority requirements. In New Zealand, the installation must conform to the New Zealand Building Code G12.**

The power supply must be protected by an individual circuit breaker at the main electrical supply switchboard and rated to suit the booster size. The supply to the heat pump water heater can be operated directly from the switchboard or via a remotely mounted switch or time clock as requested by the customer. The heater must be provided with a suitable means for disconnecting the power supply.

PARTS' NAMES

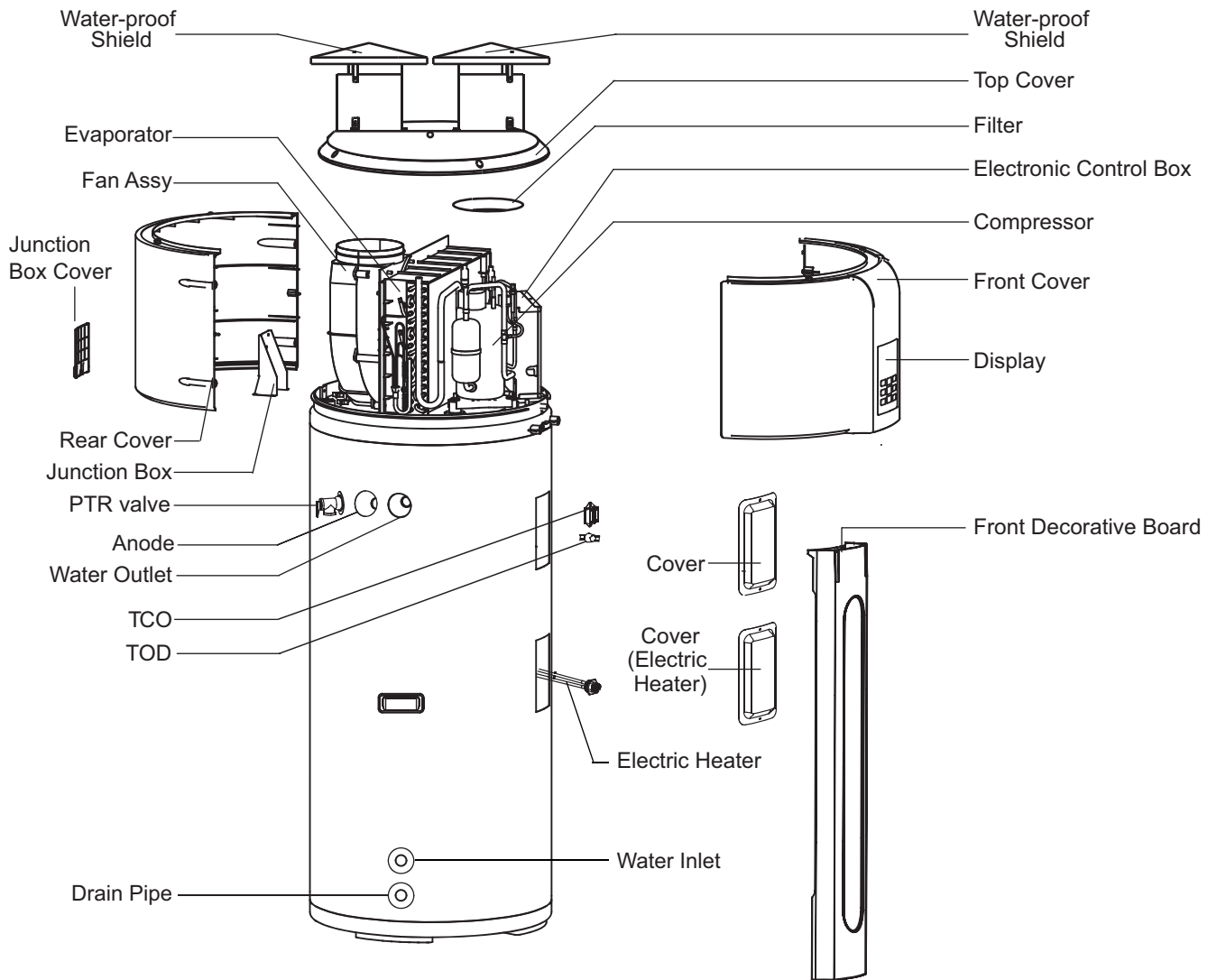

When ordering repair parts please always give the following information:

- 1) Model, serial and product number.
- 2) Parts name.



NOTE

All the picture in this manual are for explanation purpose only. They may be slightly different from the heat pump water heater you purchased (dependant on model). Please refer to the real product instead of the picture of this manual.

CONTENTS

PAGE

BASIC OPERATION PRINCIPLE..... 1
SAFETY INFORMATION..... 1
BEFORE INSTALLATION..... 2
INSTALLATION..... 4
TRIAL-RUNNING..... 8
OPERATION 11
TROUBLE SHOOTING..... 14
MAINTENANCE..... 16
SPECIFICATIONS..... 17
MIDEA– HEAT PUMP MANUFACTUR-ER’S WARRANTY..... 18

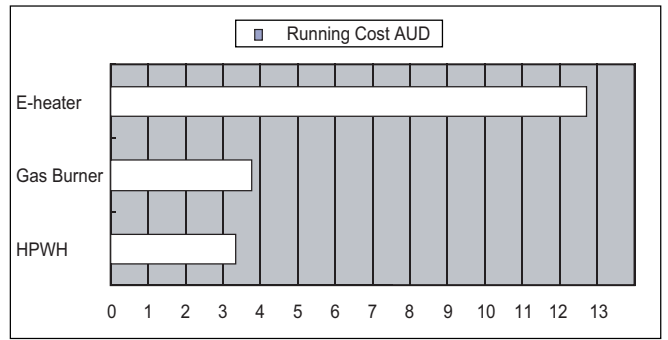

Fig. 1-1



NOTE

Above calculations are based on ideal conditions, the final amount will be different the actual running will vary with conditions, such as running period, ambient temperature, etc.

0. BASIC OPERATION PRINCIPLE

We know from experience, the natural flow of heat, moves from a higher to a lower temperature source, a heat pump can transfer heat from a lower temperature source to a higher temperature source with high efficiency.

The advantage of a heat pump water heater is that it can supply more heat energy, normally 3:1 times than input electricity power by extracting the heat from ambient atmosphere in a free-of charge way and transfer to Sanitary Hot Water. Compared to a traditional water heater, such as electric water heater or gas burner water heater, their efficiency is normally less than 1:1, which means you can dramatically cut off the bill of family daily SHW by the application of heat pump water heater, the following examples will show more details.

Power consumption comparison under the same condition to heat 1 ton of water from 15°C to 55°C.

$$Q=cM(T1-T2)=1(kCal/kg^{\circ}C) \times 1000(kg) \times (55-15)^{\circ}C=40000kCal=168MJ=46.67kW^*h$$

Table 0-1

	HPWH	Gas Burner	E-heater
Energy Resource	Air,Electricity	Gas	Electricity
Transfer Factor	860kCal/kW*h	8905kCal/m ³	860kCal/kW*h
Average Efficiency (W/W)	3.5	0.8	0.95
Energy Consumption	13.33kW*h	210MJ	49.13 kW*h
Unit Cost	0.25 AUD/kW*h	1.7C/MJ	0.25 AUD/kW*h
Running Cost AUD	3.33	3.57	12.28

1. SAFETY INFORMATION

Please read thoroughly all of the instructions before installing or operating the unit.

The following safety warnings are very important, always read and obey all safety symbols:



WARNING

- The unit must be earthed effectively.
- A RCD breaker must be installed adjacent to the power supply.
- Do not remove, cover or deface any permanent instructions, labels, or the data label from either the outside of the unit or inside of unit panels.
- Only qualified persons should perform the installation of this unit in accordance with local national regulations and this manual.
 Improper installation may result in water leakage, electric shock or fire.
- Ask qualified person for relocating, repairing and maintaining the unit.
 Improper installation may result in water leakage, electric shock or fire.
- Electric connection work should comply with the instructions of local power company, local electric utility and this manual.
- Never use an incorrectly fuse rated, otherwise the unit may break down and risk of electrical fire.
- Do not insert fingers, rods or other objects into the air inlet or outlet. The fan is rotating at high speed, and may cause injury.
- Never use a flammable spray such as hair spray, lacquer paint near the unit. It may cause a fire.
- This appliance is not intended for use by persons (including children) with reduced physical, sensory or mental capabilities, or lack of experience and knowledge, unless they have been given supervision or instruction concerning use of the appliance by a person responsible for their safety. Children should be supervised to ensure that they do not play with the appliance.

- If the supply cord is damaged, it must be replaced by the manufacturer or its service agent or a similarly qualified person.

- **DISPOSAL:** Do not dispose this product as unsorted municipal waste. Collection of such waste separately for special treatment is necessary. Do not dispose of electrical appliances as unsorted municipal waste, use separate collection facilities. Contact your local government for information regarding the collection systems available.



- If electrical appliances are disposed of in landfills or dumps, hazardous substances can leak into the groundwater and get into the food chain, damaging your health and well-being.



CAUTION

- The earthing pole of socket must be well grounded, make sure that power supply socket and plug are dry and connected tightly.
- Before cleaning, be sure to stop the operation and turn the breaker off or pull out the power plug. Otherwise, an electric shock and injury may be caused.

- Water temperature over 50°C can cause severe burns instantly or death from scalds. Children, disabled and elderly are at highest risk of being scalded. Feel water before bathing or showering. Water temperature limiting valves are required as per AS 3500.



- Do not operate the unit with a wet hand. An electric shock may be caused.
- The installation height of power supply should be over 1.8m, if there is any water exposure, steps must be taken to separate the power supply from water.
- A one-way valve must be installed on the water inlet side, as well as an isolation valve.
- It is normal for some water to be released from the PTR valve during operation. But, if there is a large volume of water, call your service agent for instructions. After long term use, check the unit base and fittings. If damaged, the unit may sink, resulting in injury. Arrange the drain pipe to ensure smooth draining. Improper drainage work may cause wetting of the building, furniture etc. Do not touch the inner parts of the controller or remove the front panel. Some parts inside are dangerous to touch, and damage may be caused.
- Do not turn off the power supply.

System will stop or restart heating automatically. A continuous power supply for water heating is necessary, except service and maintenance.

Hydrogen gas is extremely flammable, and may build up if no water is drawn of for several weeks. To reduce the risk of injury under these conditions, it is recommended that the hot water tap is opened for several minutes at the kitchen sink before using any electrical appliance connected to the hot water system. When hydrogen is present, there will probably be an unusual sound such as air escaping through the pipe as the water begins to flow. There should be no smoking or open flame near the tap at the time it is open.

2. BEFORE INSTALLATION

2.1 Unpacking

2.1.1 Accessories

Table. 2-1

Accessory Name	Qty.	Sharp	Purpose
Owner's & Installation Manual	1		Installation and use instruction This manual
One Way Valve	1		Prevent water from flowing backwards
Drain pipe for water condensation	1		Use for draining the condensate water
Water-proof Shield	2		Must be installed. Separately package.

2.1.2 How to transport

- 1) In order to avoid scratch or deformation of the unit surface, apply guard boards to the contacting surface. No contact of fingers and other things with the vanes. Don't incline the unit more than 75° in moving, and keep it vertical when installing.

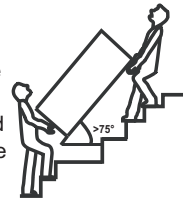

Gradient limit >75°

- 2) This unit is heavy, it need to be carried by two or more persons, otherwise might cause injury and damage.

2.2 Location requirements

- 1) Enough space for installation and maintenance shall be preserved.
- 2) The air inlet and outlet should be free from obstacles and strong wind.
- 3) The base surface should be flat, surface should be inclined no more than 2° and able to bear the weight of the unit and suitable for installing the unit without increasing noise or vibration.
- 4) The operation noise and air flow expelled shall not affect neighbors.
- 5) No flammable gas is leaked nearby.
- 6) It is convenient for piping and wiring.
- 7) If it is installed in indoor space, it might cause indoor temperature decrease and noise, Please take preventive measures for this.
- 8) If the unit has to be installed on a metal part of building, make sure the well electric insulation which should meet the relevant local electric standard.



CAUTION

- The ambient air temperature must also be considered when installing this unit, in heat pump mode the ambient air temperature must be above -7°C and below 43°C. If the ambient air temperature falls outside these upper and lower limits, the electrical elements will activate to meet the hot water demand and the heat pump will not operate.
- The unit should be located in an area not subject to freezing

temperatures. The unit located in unconditioned spaces (i.e., garages, basements, etc.) may require the water piping, condensate piping, and drain piping to be insulated to shelter against freezing.



CAUTION

Installing the unit in any of the following places may lead to malfunction (if it is inevitable, consult the supplier prior to purchase).

- The site contains mineral oils such as lubricant of cutting machines.
- Seaside or where the air contains salt.
- Hot spring area where corrosive gases exist, e.g., sulfide gas.
- Factories where the power voltage fluctuates seriously.
- Inside a car or cabin.
- The place with direct sunlight and other heat supplies. If there's no way to avoid these, please install a cover.
- Places like kitchen where oil may permeate system.
- Place where strong electromagnetic fields exist.
- Place where flammable gases or materials exist.
- Place where acidic or alkaline gases exist.
- Other special environments.



WARNING

- The unit must be securely fixed, otherwise, noise and vibration may result.
- Make sure that there are no obstacle around the unit.
- In places where there are strong wind like seaside, fix the unit in a location protected from the wind.

2.3 Maintenance space requirements (unit: mm)

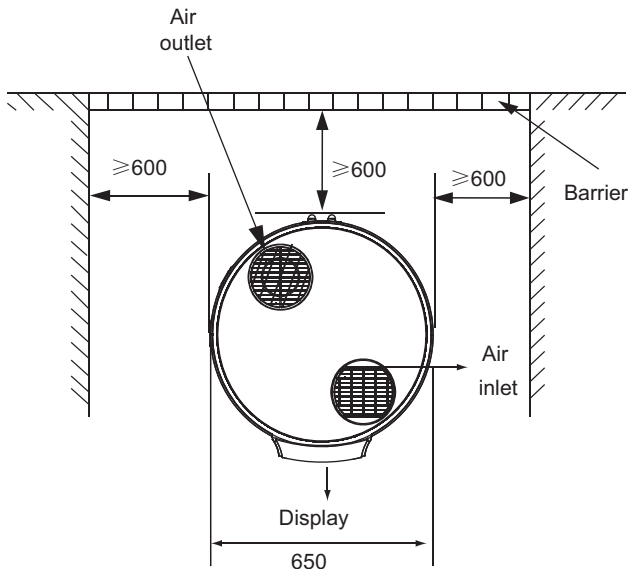

Fig.2-1

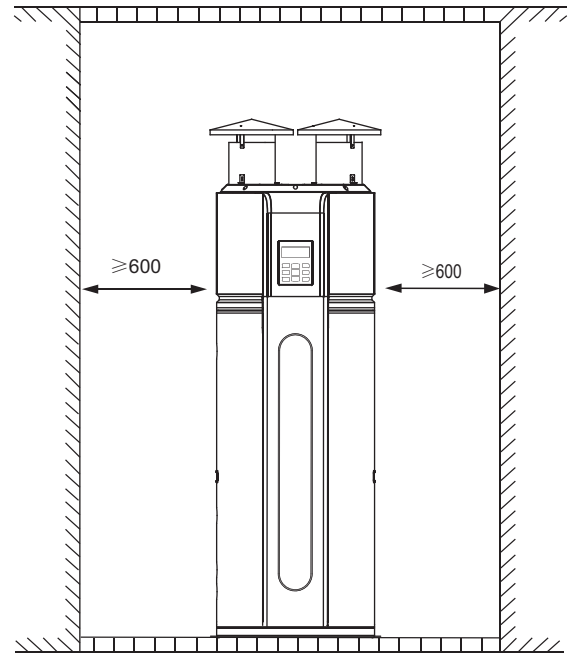

Fig.2-2

2.4 If installed in inclosed space

The water heater must be located in a space $>15\text{m}^3$, and must have unrestricted air flow. As an example, a room that has an 2.5 tall ceiling and is 3 meter long by 2 meter wide would contain 15m^3 .

2.5 Unit outline dimension (unit: mm)

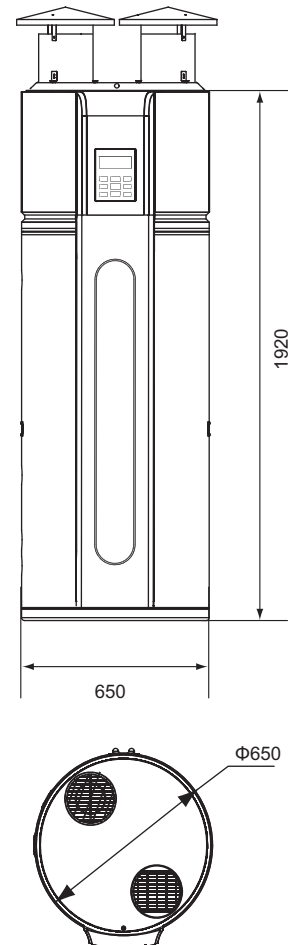

Fig.2-3

3. INSTALLATION

The circulating air for every unit should be more than 350m³/h. Make sure there is enough Installation space. Refer outline dimensional drawing(See Fig.2-3).

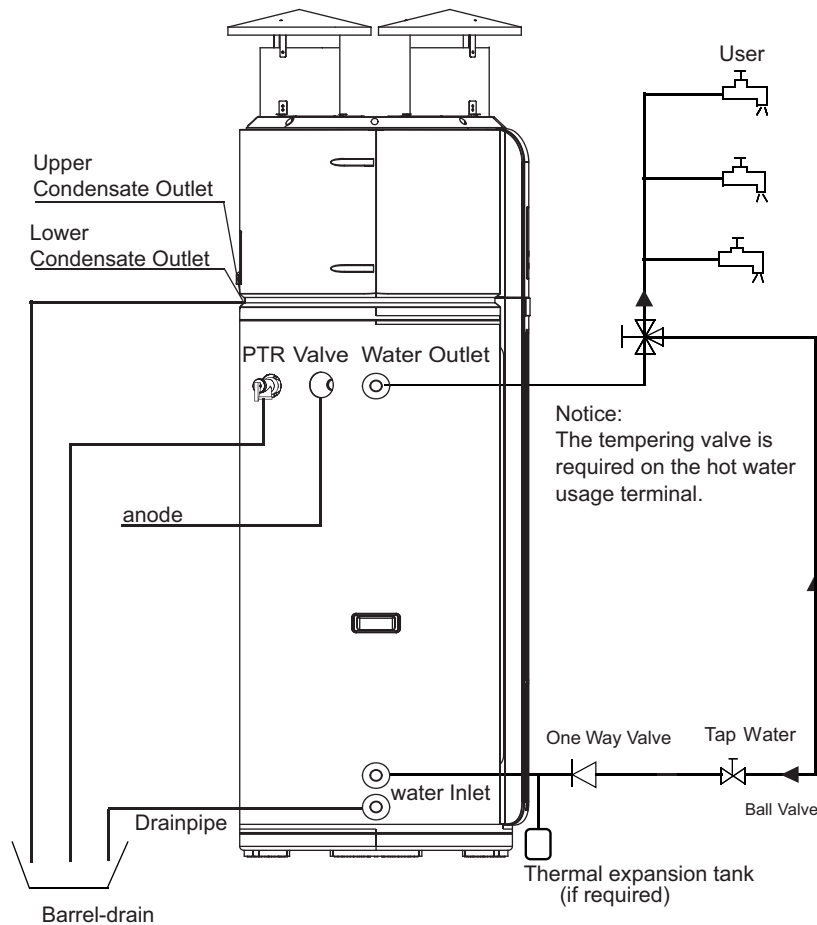

Fig.3-1

3.1 Water System Piping

Water inlet or outlet pipes: The spec of the water inlet or outlet thread is RC3/4" (external thread). Pipes must be heat-resistant and durable.

- 1) Installation of the pipe for PTR valve: The valve connecting thread is RC3/4" (internal thread). After installation, it must be confirmed that the drainpipe outlet is exposed in the air.



CAUTION

- Piping water system as the above figure. In case of installing where outside temperature falls below freezing point, insulation must be provided for all hydraulic components.
- The PTR Valve should be checked every half year to make sure that there is no restriction of the valve. Please beware of hot water from the valve. The drainage pipe should be well insulated in order to prevent water inside pipe from freezing in cold weather.

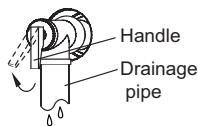

WARNING

- Do not dismantle the PTR Valve,
- Do not block off the Drainage pipe, It will cause explosion and injury.



- 2) Installation of the One Way Valve: The One Way Valve thread is RC3/4". It is used to prevent water from flowing backwards.
- 3) After connection of the water system piping work, turn on the cold water inlet valve and hot water outlet valve and bleed all air from the tank. When water flows smoothly out from water outlet pipe (tap water outlet), the tank is full, turn off all valves and check pipeline to make sure there is no any leakage.
- 4) If the inlet water pressure is less than 0.15MPa, a pump should be installed at the water inlet. To guarantee the safety usage of tank, a reducing valve should be installed in the water inlet pipe, if the water pressure exceeds 500KPa.
- 5) Condensate may be leaked from unit if drainage pipe is blocked, a drainage pan is recommended as shown as following figure:

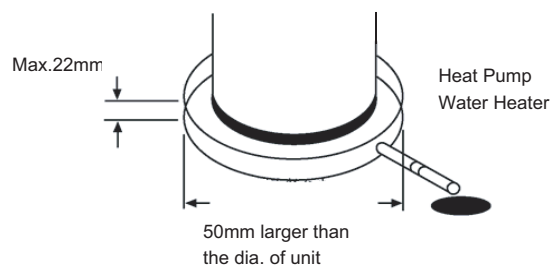

Fig.3-2

3.2 Water-proof shield installation

1) Air inlet and outlet with water-proof shield.

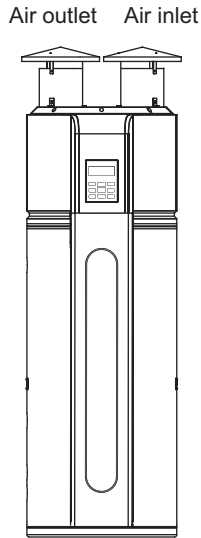

Fig.3-3



WARNING

- When outdoor installation is required two separate water-proof shields must be installed, otherwise it may cause short-circuit and electric shock because of water ingress. (Fig.3-3)
- In case of rain entering to internal components of the unit, the component might be damaged or causing physical danger. (Fig.3-4)

2) Filter needs to be installed at the air inlet position. (Fig.3-5)

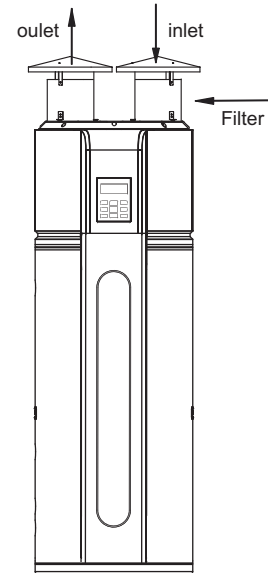

Fig.3-5



NOTE

- When water-proof shield is installed condensate will be generated around the outside of water-proof shield.
- For your safety, please do not take off the front decorated palte.

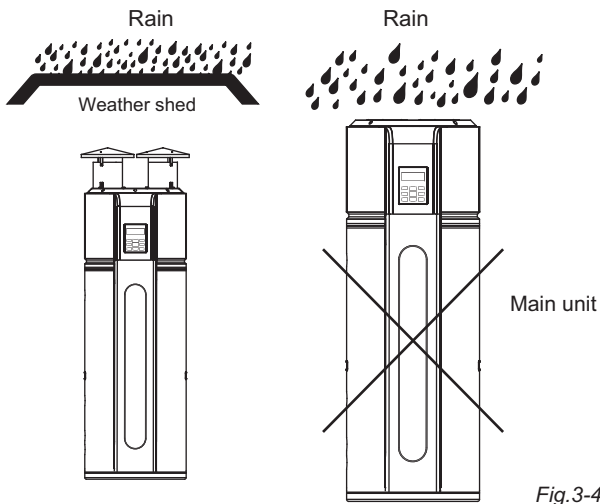

Fig.3-4

3) To smoothly drain condensate from unit, please install the main unit on a horizontal floor. Otherwise, please ensuring the drain vent is at the lowest level. Recommended inclination angle of unit to the ground should be no more than 2° . (Fig.3-6)

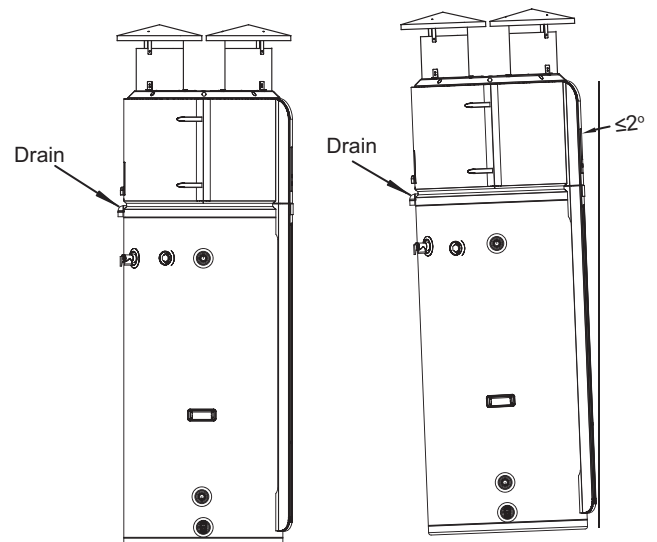

Fig.3-6

3.3 Electric Connection

3.3.2 Specifications of Power Supply

Table. 3-2

Model Name	RSJ-35/300RDN3-D
Power Supply	220-240V~50Hz
Min. Diameter of Power Supply cord (mm ²)	4
Earth cord (mm ²)	4
Manual Switch(A) Capacity/Fuse (A)	40/30
Creepage Breaker	30 mA ≤0.1sec

- Please choose the power cord according to above table, and make sure it comply with local electric standard.
- Recommended power cord mode is H05RN-F.



CAUTION

- The power supply should be hard wired.
- Power supply circuit should be earthed effectively. The wiring must be performed by professional technicians in accordance with national wiring regulations and the circuit diagram below.
- An all-pole disconnection device which has at least 3mm separation distance in all pole and a residual current device (RCD) with the rating of above 10mA shall be incorporated in the fixed wiring according to the national rule.
- Set the electric leakage protector according to the relevant electric technical standards of the state.
- The power cord and the signal cord shall be laid out neatly and properly without mutual interference or contact the connection pipe or valve.
- After wire connection, check it again and make sure of connection before power is turned on..



WARNING

The unit must be installed with an RCD near the power supply and must be effectively earthed.

3.3.1 Electric Wiring Illustration

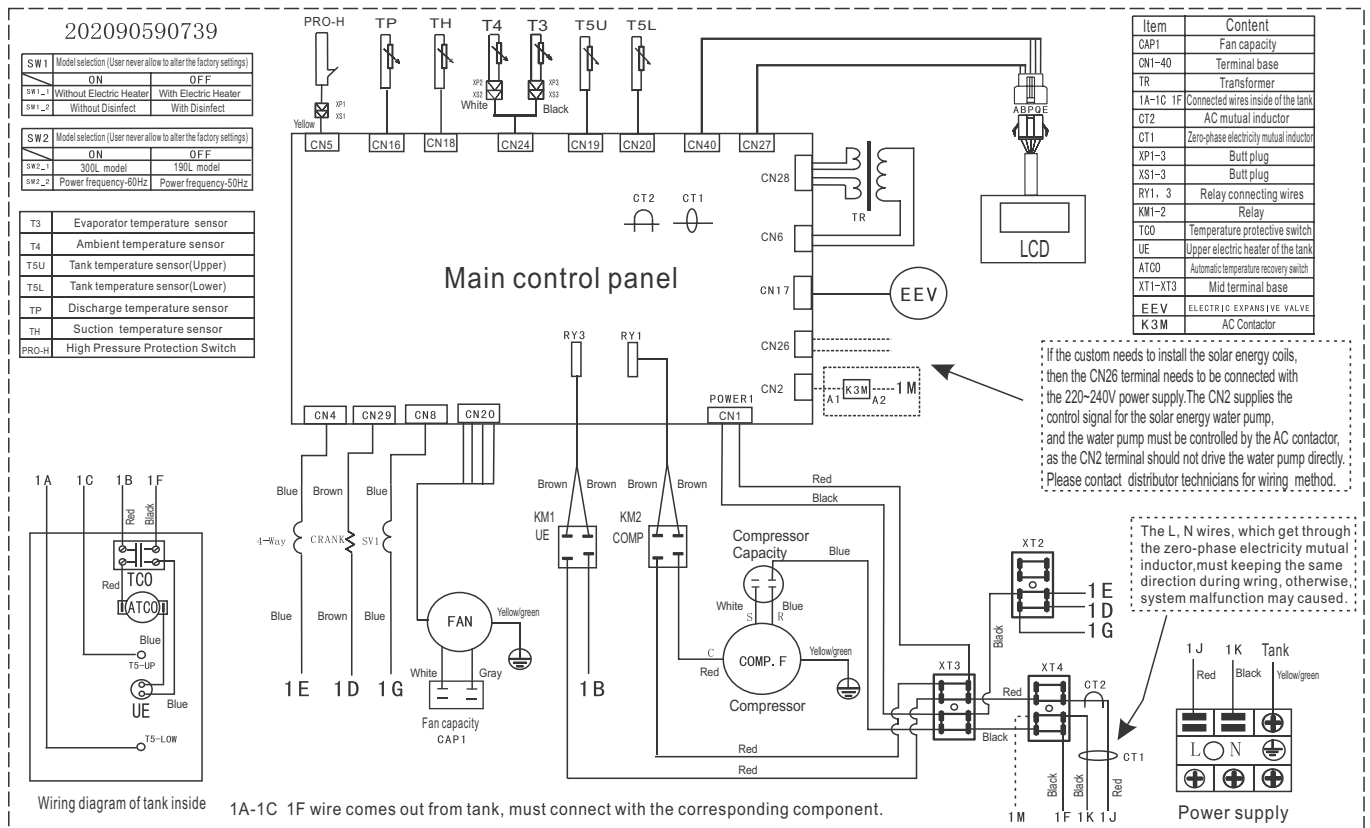

- T3: Evaporator Temp. Sensor
- T4: Ambient Temp. Sensor
- T5U: Tank Temp. Sensor (upper)
- T5L: Tank Temp. Sensor (lower)
- TP: Discharge Temp. Sensor
- TH: Suction Temp. Sensor

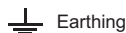

Earthing

Fig.3-7

3.3.3 PCB I/O Ports description

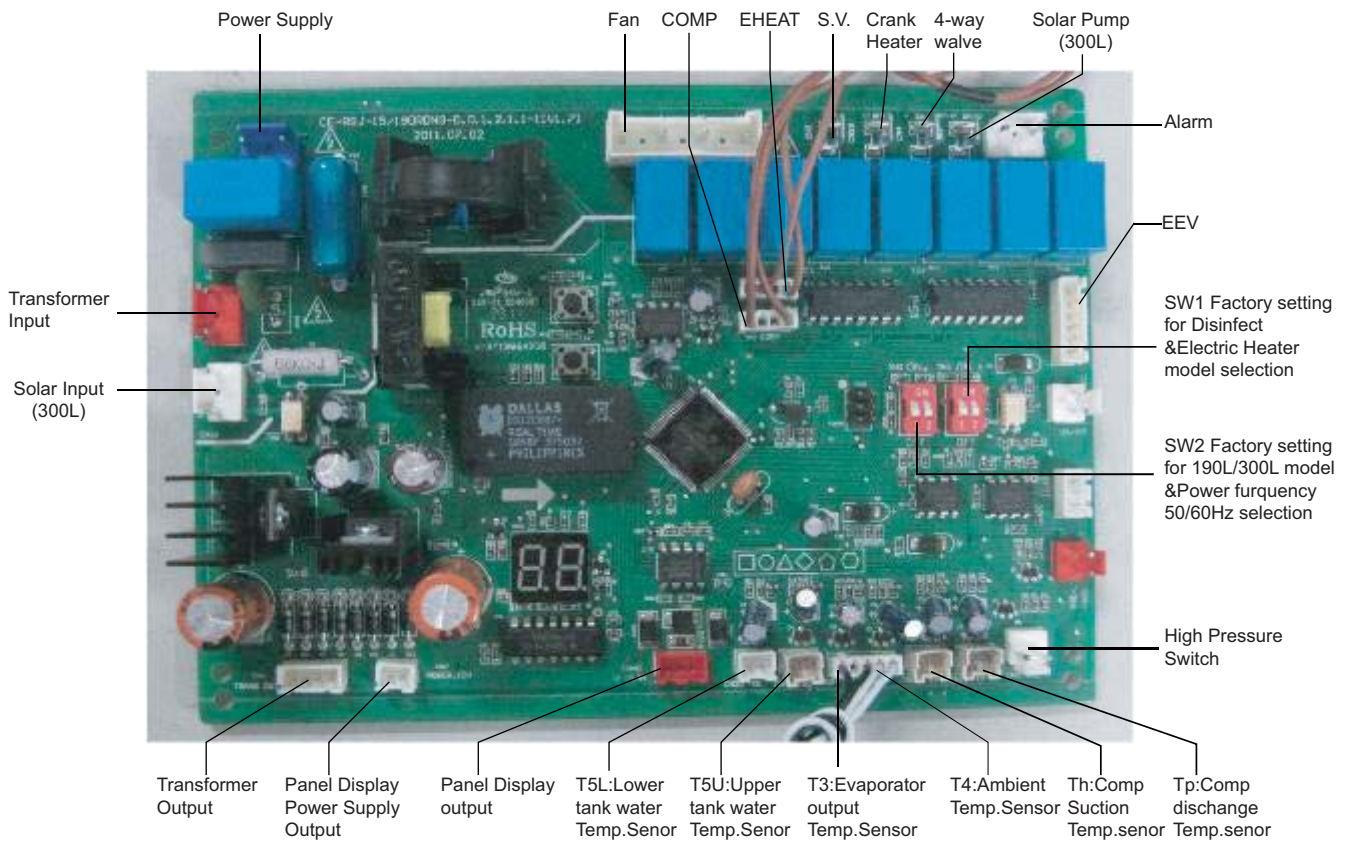

Fig.3-8

3.3.4 Switch setting

- PCB has 2 bits of switches.

Table. 3-4

SW1	Model selection (User never allow to alter the factory settings)	
	ON	OFF
SW 1 - 1	Without Electric Heater	With Electric Heater
SW 1 - 2	Without Disinfect	With Disinfect

Table. 3-5

SW2	Model selection (User never allow to alter the factory settings)	
	ON	OFF
SW 2 - 1	300L model	190L model
SW 2 - 2	Power frequency-60Hz	Power frequency-50Hz

3.3.5 Electric leakage protector

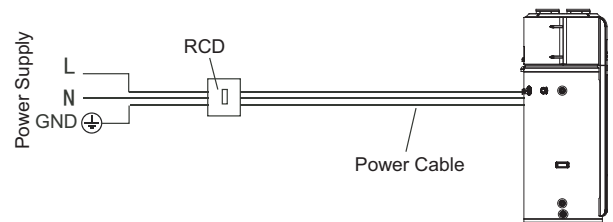

Fig.3-9

3.4 Installation checklist

3.4.1 Location

- The flooring beneath the water heater must be able to support the weight of the water heater when filled with water (286kg full).
- Located indoors (such as a basement or garage) and in a vertical position. Sheltered from freezing temperatures.
- Provisions made to shelter the area from water damage. Metal drain pan installed and piped to an adequate drain.
- Sufficient room to service the water heater.
- Sufficient air for the heat pump to function, the water heater must be located in a space >15m³, and must have unrestricted air flow.



NOTE

For optimal efficiency and serviceability, the following clearances should be maintained: 800mm on the air inlet side, 800mm on the air outlet side, 600mm in the back, and 600mm in the front.

- The unit cannot be placed into any type of closet or small enclosure.
- The site location must be free from any corrosive elements in the atmosphere such as sulfur, fluorine, and chlorine. These elements are found in aerosol sprays, detergents, bleaches, cleaning solvents, air fresheners, paint, and varnish removers, refrigerants, and many other commercial and household products. In addition excessive dust and lint may affect the operation of the unit and require more frequent cleaning.
- The ambient air temperature must be above -7°C and below 43°C. If the ambient air temperature falls outside these upper and lower limits the electrical elements will be activated to meet the hot water demand.

3.4.2 Water System Piping

- PRT(Temperature and pressure relief valve) properly installed with a discharge pipe run to an adequate drain and sheltered from freezing.
- All piping properly installed and free of leaks.
- Unit completely filled with water.
- Tempering valve installed per manufacturer's instructions.

3.4.3 Condensate Drain Line Installation

- Must be located with access to an adequate drain or condensate pump.
- Condensate drain lines installed and piped to an adequate drain or condensate pump.

3.4.4 Electrical Connections

- The water heater requires 230 VAC for proper operation.
- Wiring size and connections comply with all local applicable codes and the requirements of this manual.
- Water heater and electrical supply are properly grounded.
- Correctly sized overload fuse or circuit breaker protection installed.

3.4.5 Post Installation Review

- Understand how to use the User Interface Module to set the various modes and functions.
- Understand the importance of routine inspection/maintenance of the condensate drain pan and lines. This is to help prevent any possible drain line blockage resulting in the condensate drain pan overflowing.
- IMPORTANT: Water coming from the plastic shroud is an indicator that both condensation drain lines may be blocked. Immediate action is required.
- To maintain optimal operation check, remove and clean the air filter.

4. TRIAL-RUNNING

4.1 Water affusion before operation

Before using this unit, please follow the steps below.

Water Affusion: If the unit is used for the first time or used again after emptying the tank, please make sure that the tank is full of water before turning on the power. Method: see Fig.4-1

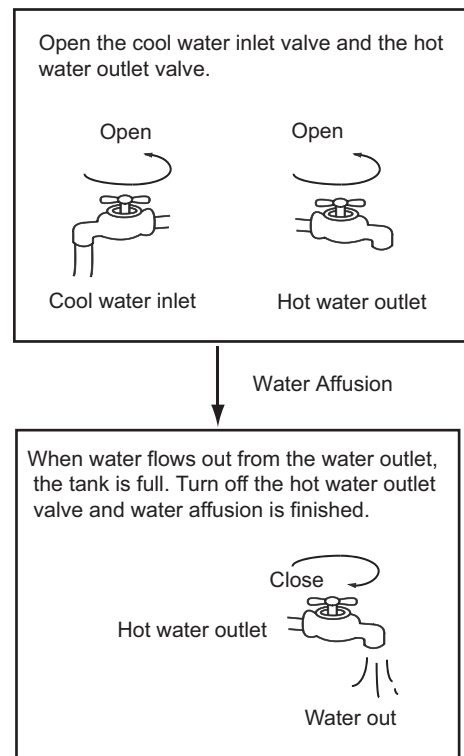

Fig.4-1



CAUTION

- Operation without water in water tank may result in the damage of auxiliary e-heater. In case of such damage, the manufacturer will not be liable for any damages caused by this issue.
- After powered on, the display lights up. Users can operate the unit through the buttons under the display.
- Emptying: If the unit needs cleaning, moving etc, the tank should be emptied. Method: See Fig.4-2:

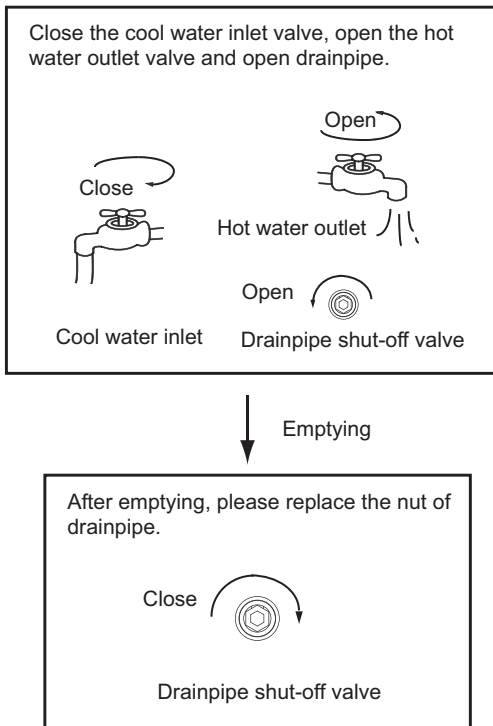

Fig.4-2

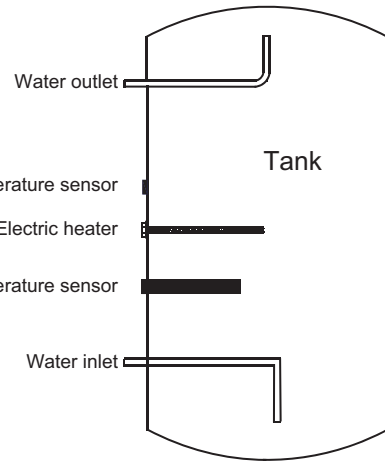

Fig.4-3

2) Water Temperature Display

The temperature shown on the display depends on the upper sensor. It is normal that the display temperature has reached to target temperature but compressor still running, because the lower water temperature does not meet to target temperature.

3) Modes will be automatically selected by unit. Mode can not be selected by manual operation.

• Running Temperature Range

Setting water temperature target range: 38~60°C.

E-heater running ambient temperature range: -20~45°C.

Heat pump running ambient temperature range: -7~43°C.

Water temperature limits:

Table. 4-1

Model	RSJ-35/300RDND3-D					
Ambient temp.(T4)	T4 < -7	-7 ≤ T4 < -2	-2 ≤ T4 < 2	2 ≤ T4 < 7	7 ≤ T4 < 45	T4 ≥ 45
Max.Temp.(Heat pump)	--	42	47	55	60	--
Max.Temp.(E-heater)	60	60	60	60	60	60

4) Heat Source Shift

- The default heating source is heat pump.
If ambient temperature range is out of heat pump operating range, heat pump will stop running, the unit will shift automatically to activate E-heater and show the icon LA() on the display, then if the ambient temperature goes into the running range of heat pump again, it will stop E-heater and shift automatically to heat pump again, and the icon LA() will be extinguished.
- If the target setting water temperature is higher than Maximum temperature(Heat pump), the unit will activate heat pump firstly to the Maximum temperature, then stop heat pump, activate E-heater to continually heat water to the target temperature.
- If manually activate the E-heater running mode when heat pump running, E-heater and heat pump will work together until the water temperature gets to target temperature. So to increase recovery rate, please manually activate E-heater.



NOTE

E-heater will only be activated once for the current heating progress, E-heater can be applied again by push **E-HEATER**.

4.2 Trial- running

4.2.1 Checking list before commissioning.



- 1) Checking list before trial-running.
- 2) Correct installation of the system.
- 3) Correct connection of water/air piping and wiring.
- 4) Condensate draining smoothly well insulation work for all hydraulic part.
- 5) Correct power supply.
- 6) No air in the water pipeline and all valves opened.
- 7) Effective RCD installed.
- 8) Sufficient inlet water pressure (between 0.15Mpa and 0.65MPa).

4.2.2 About Running

1) System Structure Figure

Unit has two kinds of heat sources: Heat pump(compressor) and electric heater.

The unit will automatically select heat sources to heat water to the target temperature.

- If system occurs some malfunctions, error code "E7" and  will be shown on the display, then heat pump will stop running, and the unit will shift automatically to E-heater mode as the backup heat source, but the code "E7" and  will be shown until power is reset.



NOTE

If only use E-heater mode, about 150 liters water will be heated, so set higher target water temperature if ambient temperature is out of heat pump running range.

- Defrosting During Water-heating**
In heat pump running period, if the evaporator frosted in lower ambient temperature, the system will defrost automatically to keep effective performance(about 3~10min). At defrosting time, the fan motor will stop, but compressor will still run.
- COP**
COP varies at different ambient temperature. Normally lower ambient temperature result in longer heat-up time because of lower effective performance.

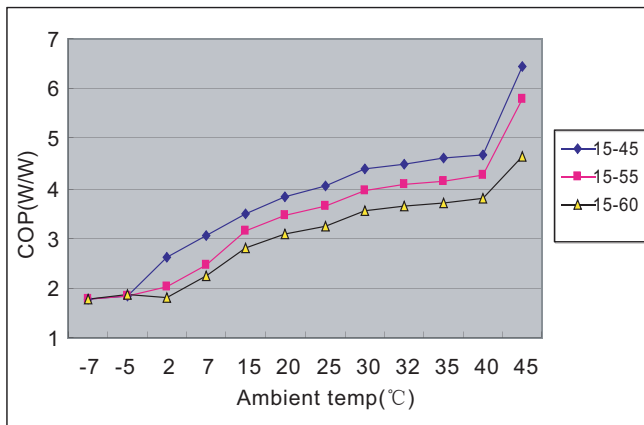

Fig.4-5

- When ambient temp below 2°C, heat pump and E-heater will take different portions of heating capacity, generally the lower of ambient temperature, the lower portion of heat pump will contribute as well as the higher portion of E-heater will provide more detail please refer to Table.4-1.
- About TCO (Thermal-cutoff) and ATCO (Automatic thermal-cutoff).
The power of E-heater will be automatically shut-off or turn on by TCO and ATCO.

If the water temperature is higher than 78°C, the ATCO will automatically shut off the power of E-heater, and turn back on when the temperature falls down below 68°C.





If the water temperature is higher than 85°C, the TCO will automatically shut off the power of E-heater, it must be reset manually.
- Restart After a Long Term Stop**
When the unit is restarted after a long term stop(trail running included), it is normal that outlet water is unclean. Turn the tap on and the water will be flushed clean.



NOTE

While the ambient temperature below than -7°C, heat pump efficiency will decrease dramatically, the unit will automatically shift to E-heater mode.

4.2.3 Basic function

- Weekly disinfect function**
Under disinfection mode unit immediately starts to heat water up to 65°C to kill the potential legionella bacteria inside water of tank, "  "icon will light on the display screen during disinfection;Unit will quit disinfection mode if water temperature is higher than 65°C and extinguish "  "icon.
- Vacation mode:**
After pressing "Vaction" button, Unit will automatically heat water to 15°C for the purpose of energy saving during vacation days.
- How is the unit running:**
If unit is OFF->press  ->unit will be unlocked->press  to set target water temperature(38-60°C)->press  ->unit will automatically select mode and start to heat water to target temperature.

4.2.4 Query function



For the convenience of maintenance and debug, query function is available by Press 2 buttons together: **E-HEATER** + **DISINFECT**, then system running parameters will be shown one by one with following sequence by each pushing of "  " or "  " button.

Table. 4-2

No.	Hour low bit	Min. high bit	Min. Low bit	Temp./Dasys	Explanation
1		5	U	Temp.	T5U
2		5	L	Temp.	T5L
3		t	3	Temp.	T3
4		t	4	Temp.	T4
5		t	p	Temp.	TP
6		t	h	Temp.	Th
7		l	E	Current	Compressor
8	1				Last error code
9	2				Previous 1st error or protection code
10	3				Previous 2nd error or protection code
11					Software number

5. OPERATION

5.1 Control Panel Explanation

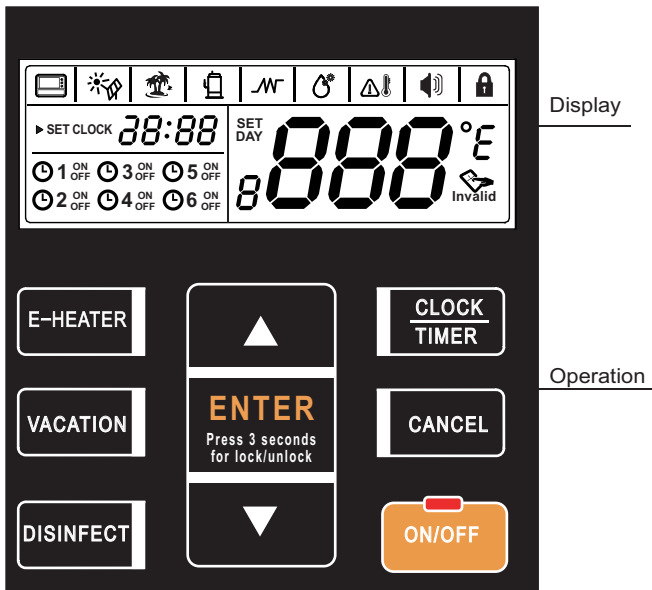

Fig.5-1

5.2 Display Explanation

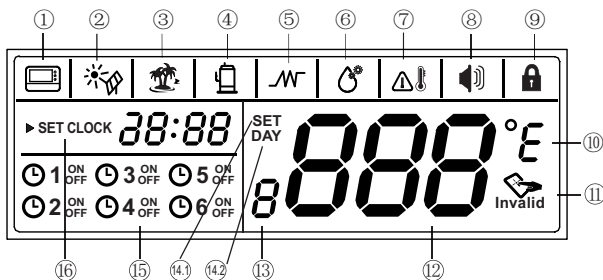

Fig.5-2

Table. 5-1

No	Icon	Description
①		Wire controller: If a wire controller is connected, will be lightened; otherwise be extinguished.
②		Outside solar heat source: If an outside solar heat source has been connected to the unit, will flash with 0.5Hz frequency; otherwise will be extinguished.
③		Vacation mode: will be lightened if the unit is under vacation mode, otherwise will be extinguished; will flash with 2Hz frequency when setting vacation mode.
④		Compressor: will be lightened when compressor is running, otherwise will be extinguished.

No	Icon	Description
⑤		E-heater: will be lightened if e-heater is activated, otherwise will be extinguished. If e-heater is automatically activated by unit, will be lightened; If e-heater is manually activated, will flash with 0.5Hz frequency. When setting e-heater manually ON/OFF, will flash with 2 Hz frequency.
⑥		Disinfect: will be lightened when the unit is under disinfect mode, otherwise will be extinguished. will be lightened if disinfect mode is automatically activated by unit; will flash with 0.5Hz frequency, if disinfect mode is manually activated; will flash with 2Hz frequency when setting disinfect mode or setting disinfect timer.
⑦		High temp. Alarm If setting water temp. is higher than 50℃, will be lightened, otherwise will be extinguished.
⑧		Alarm: When unit is under protection/error, will flash with 5Hz frequency as well as buzzer will sound 3 times every 1 minute until protection/error eliminated or press CANCEL for 1 second.
⑨		Lock: If button is locked, will be lightened, otherwise will be extinguished.
⑩		Temperature unit If setting temperature unit as celsius, °C will be lightened, 888 will show celsius degree; If setting temperature unit as Fahrenheit, °F will be lightened, 888 show Fahrenheit degree.
⑪		Invalid If button is under lock mode, press any button except unlock button, will be lightened;
⑫		888: will be lightened if screen is unlocked. It shows water temperature on normal mode; It shows remaining vacation days on vacation mode; It shows setting temperature under setting mode; It shows unit setting/running parameters, error/protection code under query mode.
⑬		Reserved
⑭①		Water Temperature setting SET will be lightened when setting water temperature or setting days for vacation.
⑭②		Date setting DAY will be lightened when setting days for vacation; DAY will be lightened when under vacation mode.

No	Icon	Description
15		<p>Timer</p> <p>There are six timers available. If anyone of them has been set, 01, 02, 03, 04, 05, 06 will lighten the corresponding one when screen is unlocked; If there is none of timers has been set, the icon will keep extinguished. If timer is being set, 01, 02, 03, 04, 05, 06 will flash the corresponding one with 2HZ frequency and lighten the timer which has been set.</p>
16		<p>Clock and clock setting</p> <p>28:28 shows the clock. Whenever there is any setting for clock, SET CLOCK will be lightened.</p>

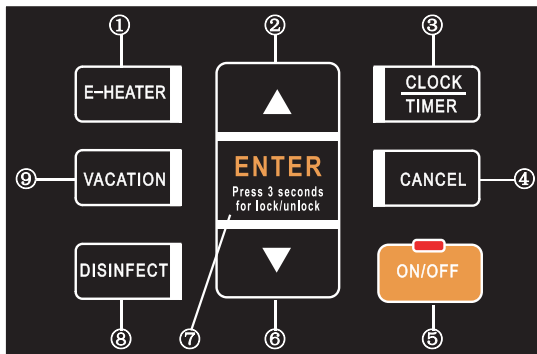

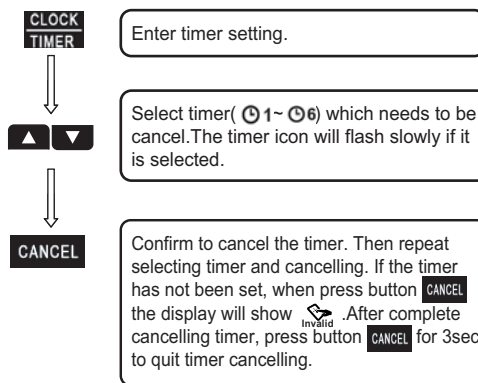

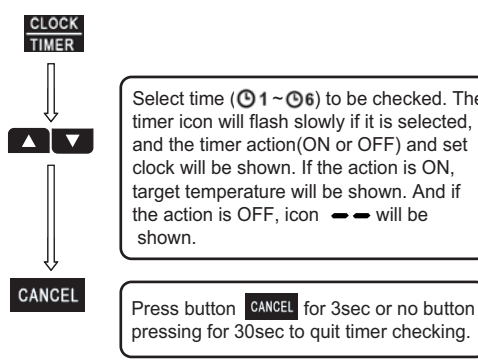





Fig.5-3







Only in unlocked state, pressing the button is functional.

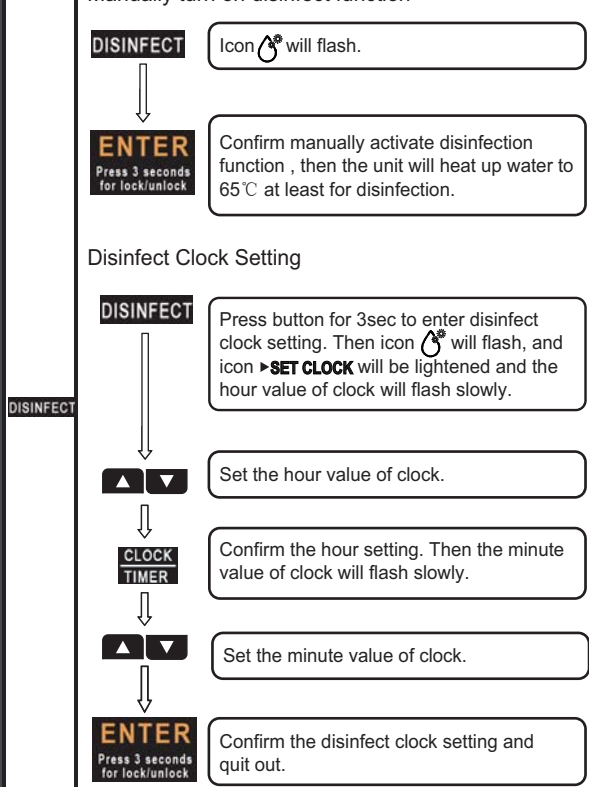

Table. 5-2

No.	Icon	Description
1		<p>Manually turn e-heater ON</p> <p>If E-heater is OFF, follow these steps below to manually turn it on.</p> <p> Icon will flash.</p> <p> Confirm manually turning E-heater on, then E-heater is activated to heat up water to the target temperature. If it needs manually turn E-heater on again, it has to repeat these steps.</p> <p>If E-heater is already ON, Press will lead to show invalid icon on the display.</p>
2		<p>▲ INCREASE</p> <p>If screen is unlocked, corresponding value will increase by pushing .</p> <ul style="list-style-type: none"> When setting temperature, press more than 1s, Temperature value will be increased continuously; When Setting clock/timer, press more than 1s, Clock/timer value will be increased continuously; When setting vacation days, press more than 1s, day value will be increased continuously; <p>Under query mode, check items will page up by pressing .</p>

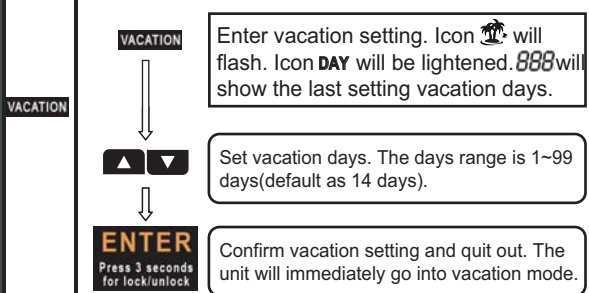





No	Icon	Description
3.1		<p>Set Clock</p> <p> Press button for 3 sec to enter clock setting. Then icon will be lightened and the hour value of clock will flash slowly.</p> <p> Set the hour value of clock.</p> <p> Confirm the hour setting. Then the minute value of clock will flash slowly.</p> <p> Set the minute value of clock.</p> <p> Confirm the minute setting and quit clock setting.</p>
3.2		<p>Set Timer</p> <p> Enter timer setting.</p> <p> Select timer(01~06) to be set. The timer icon will flash slowly if it is selected.</p> <p> Confirm the selected setting timer. Then will be lightened. Then the hour value of timer will flash slowly.</p> <p> Set the hour value of timer.</p> <p> Confirm the hour value of timer. Then the minute value of timer will flash slowly.</p> <p> Set the minute value of timer.</p> <p> Confirm the minute value of timer. Then ON or OFF icon following the setting timer will flash slowly.</p> <p> Set the action(ON or OFF) of the timer.</p> <p> Confirm the action(ON or OFF) of the timer.</p> <p> The display screen will automatically display different value at by different action. It will display the last set temperature and icon , if the action is ON, or will display if the action is OFF.</p> <p> Set the water temperature of the setting timer.</p> <p> Confirm and complete the timer. Then repeat this process to set another timer.</p>

No	Icon	Description
		<p>Cancel Timer</p>  <p>Enter timer setting.</p> <p>Select timer(1~6) which needs to be cancel. The timer icon will flash slowly if it is selected.</p> <p>Confirm to cancel the timer. Then repeat selecting timer and cancelling. If the timer has not been set, when press button CANCEL the display will show . After complete cancelling timer, press button CANCEL for 3sec to quit timer cancelling.</p> <p>Check Timer</p>  <p>Select time (1~6) to be checked. The timer icon will flash slowly if it is selected, and the timer action(ON or OFF) and set clock will be shown. If the action is ON, target temperature will be shown. And if the action is OFF, icon  will be shown.</p> <p>Press button CANCEL for 3sec or no button pressing for 30sec to quit timer checking.</p> <p>If there is confliction between Timer and Manually ON: 1) The moment of Manually ON has priority; 2) The moment of timer OFF has priority;</p>
④	CANCEL	<p>CANCEL CANCEL</p> <p>To cancel setting, quit setting, clear alarm, ect. To clear alarm buzzer, need to press for 1sec.</p>
⑤	ON/OFF	<p>ON/OFF ON/OFF button and LED indicator</p> <p>If unit is standby, press ON/OFF, then unit will be OFF. If unit is ON, press ON/OFF, then unit will be OFF. If unit is OFF, press ON/OFF, then unit will be ON. LED indicator  will be lightened if unit is ON or standby and extinguished if unit is OFF.</p>
⑥	Decrease/Down	<p>Decrease/Down</p> <p>If screen is unlocked, corresponding value will decrease by pushing .</p> <ul style="list-style-type: none"> When setting temperature, press more than 1s, temperature value will be decreased continuously; When Setting clock/timer, press  more than 1s, Clock/timer value will be decreased continuously; When setting vacation days, press more than 1s, day value will be decreased continuously; <p>Under query mode, check items will page down by pressing .</p>

No	Icon	Description
⑦	ENTER	<p>ENTER CONFIRM/UNLOCK</p> <p>Press 3 seconds for lock/unlock</p> <p>If screen and buttons are unlocked, press to confirm setting parameters after setting any parameter:</p> <ul style="list-style-type: none"> If press within 10sec, setting parameters will be confirmed; If press longer than 10sec, please reset all parameters. <p>If screen and buttons are locked, press for 3s to unlock them.</p>
⑧	DISINFECT	<p>DISINFECT DISINFECT</p> <p>Manually turn on disinfect function</p>  <p>Icon  will flash.</p> <p>Confirm manually activate disinfection function, then the unit will heat up water to 65°C at least for disinfection.</p> <p>Disinfect Clock Setting</p> <p>Press button for 3sec to enter disinfect clock setting. Then icon  will flash, and icon  SET CLOCK will be lightened and the hour value of clock will flash slowly.</p> <p>Set the hour value of clock.</p> <p>Confirm the hour setting. Then the minute value of clock will flash slowly.</p> <p>Set the minute value of clock.</p> <p>Confirm the disinfect clock setting and quit out.</p> <p>Unit will automatically start disinfect function at the above-set clock every 7 days. If user don't set disinfect clock, unit will automatically start disinfect function at 23:00 every 7 days. If unit is OFF or under disinfect mode, press DISINFECT will lead to show  on the display.</p>
⑨	VACATION	<p>VACATION VACATION</p> <p>Vacation Setting</p>  <p>Enter vacation setting. Icon  will flash. Icon DAY will be lightened. 888 will show the last setting vacation days.</p> <p>Set vacation days. The days range is 1~99 days(default as 14 days).</p> <p>Confirm vacation setting and quit out. The unit will immediately go into vacation mode.</p>

No	Icon	Description
⑨		In vacation mode, the setting target water temperature is 15°C as default and 888 will show the remanent vacation days. On the last day of vacation, unit will automatically start disinfect function, and automatically reset the target temperature to the last one before vacation. If unit has already been under vacation mode or OFF, press VACATION will lead to show invalid icon  on the display.

5.3 Combination button

No.	Icon	Description
Clear error code	 + 	Press the two buttons at the same time to clear all stored error & protect codes, and the buzzer will buzz one time.
Query mode	 + 	Press the two buttons at the same time for 1sec to go into query mode. Under query mode user can check unit setting & running parameters by pressing   circularly. Press button for 1s or no button CANCEL operation for 30s, then quit query mode.

5.4 Auto-restart

If electricity power failed, unit can memorize all setting parameters, unit will be back to the previous setting when power recover.

5.5 Button Auto Lock

When there is no operation of button for 1 minute, button will be locked except Unlock button () , Press  for 3s, unlock buttons.

5.6 Screen Auto Lock

If there is no operation of button for 30s, screen will be locked(extinguished) except for error code and alarm light. Press any button will unlock the screen(lighten).

6. TROUBLE SHOOTING

6.1 Non-error tips

- Q: Why can't compressor start immediately after setting?
A: Unit will wait for 3 min to balance the pressure of system before start compressor again, it's a self protection logic of unit.
- Q: Why is the temperature shown on the display panel sometimes decreased while unit is running?
A: When the upper tank temperature is much higher than the bottom part, upper part hot water will be mixed by the bottom cold water which flows from inlet tap water, so that will decrease the upper part temperature.

Q: Why is the temperature shown on the display sometimes decreased but unit still keep off?

A: To avoid unit ON/OFF frequently, unit will activate heat source only when bottom tank temperature is lower than setting temperature for at least 5 °C.

Q: Why is the temperature shown on the display sometimes will decrease dramatically?

A: It is because tank is pressure-bearable type, if there is massive hot water demand, hot water will quickly tapped out from upper part of tank at the same time cold water will quickly tapped into bottom part of tank. The cold water flows to the upper temperature sensor, the temperature shown on the display will decreased dramatically.

Q: Why is the temperature shown on the display sometime decrease a lot, but there is still a mount of hot water can be tapped?

A: This is because the upper water sensor is located on the upper 1/4 tank, when tapping hot water out, it means there is at least 1/4 tank of hot water available.

Q: Why is unit shown the icon "LA" on display ?

A: The heat pump available running ambient range is from -7 to 43°C, if ambient temperature is out of the range, system will show above-mentioned signal to let user notice it.

Q: Why is there nothing shown on the display?

A: To maintain display screen lifespan within along term, when there is no button operation for 30 sec, it will extinguish the display except the LED indicator.



Q: Why are the buttons unavailable sometimes?

A: If there is no operation on panel for 1 min, unit will lock the panel, shows "🔒", to unlock the panel, please press the "Enter" button for 3 seconds.

Q: Why is there some water flowed from drainage pipe of PTR valve?

A: It is because the tank is pressure-bearable one, when water is heated inside the tank, it will expand. So the pressure inside of tank will increase. If pressure goes up more than 1.0MPa, PTR valve will activate to release the pressure and discharge hot water correspondingly. If water is continually discharged from PTR valve drainage pipe, it is abnormal. Please contact authorised technician to check.

6.2 Something about self-protection of unit

- 1) When the self-protection mode activates, the system will be stopped and start a self-check, and restart when the error is resolved.
- 2) When the self-protection mode activates, the buzzer will buzz every second minute, the  will flash and error code will be shown at water temperature indicator. Press **CANCEL** button for 1sec to stop buzz, but the  and error code does not disappear until the error is resolved.
- 3) In the following circumstance, self-protection may happen:
If air inlet or outlet is blocked;
If the evaporator is covered with too much dust;
Incorrect power supply(exceeding the range of 220-240V).

6.3 When Error happened

- 1) If some cases at error happen, unit will automatically shift to E-heater for emergent SHW supply, please contact authorised technician staff to repair.
- 2) If case of serious errors the unit will not start, please contact authorised technician to repair.
- 3) If some errors, the buzzer will buzz 3 times every minute and the  will flash fast. Press **CANCEL** for 1 sec to stop the buzzer but the alarm icon will keep flashing.

6.4 Error phenomenon shooting

Table. 6-1

Error phenomenon	Possible reason	solution
Cold water out and display screen extinguished	Bad connection between power supply plug and socket; Setting water temperature too low; Temper sensor broken ; PCB of indicator broken ; Compressor broken.	Plug in; Setting water temp. higher; Contact service center.
No hot water out	Public water supply ceased; Cold water inlet pressure too low (<0.15 Mpa); Cold water inlet valve closed.	Waiting for public water supply recover; Waiting for inlet water pressure increase; Open water inlet valve.
Water leakage	Hydraulic pipeline joints are not sealed well.	Check and reseal all joints.

6.5 Error code shooting table

Table. 6-2

Display	Malfunction Description	Corrective action
E0	Error of sensor T5U(upper water temperature sensor)	Maybe the connection between sensor and PCB is broken or sensor has been broken. Contact a qualified person to service the unit.
E1	Error of sensor T5L(lower water temperature sensor)	Maybe the connection between sensor and PCB is broken or sensor has been broken. Contact a qualified person to service the unit.
E2	Tank and Wired Controller communication error	Maybe the connection between controller and PCB is broken or PCB has been broken.
E4	Evaporator temperature sensor T3 error	Maybe the connection between sensor and PCB is broken or sensor has been broken. Contact a qualified person to service the unit.
E5	ambient temperature sensor T4 error	Maybe the connection between sensor and PCB is broken or sensor has been broken. Contact a qualified person to service the unit.
E6	Compressor discharge temperature sensor TP error	Maybe the connection between sensor and PCB is broken or sensor has been broken. Contact a qualified person to service the unit.
E8	Electric leakage error If PCB current_induction_circuit check the current difference between L,N >14mA, system consider it as "electric leakage error"	Maybe some wires have been broken or bad wire connection. Contact a qualified person to service the unit.
E9	Compressor suction temperature sensor TH error	Maybe the connection between sensor and PCB is broken or sensor has been broken. Contact a qualified person to service the unit.
EE	E-heater open-circuit error(IEH(Current difference E-heater on & e-heater off)<1A)	Maybe the E-heater has been broken or bad wire connection after repair.
EF	Clock chip error	Maybe the chip has been broken, but unit can work well without clock-memory, so it is needed to reset clock when power put on again. If necessary, contact a qualified person to service the unit.
Ed	E-EPROM chip error	Contact a qualified person to service the unit.
P1	System high pressure protection ≥ 2.76MPa active : ≤ 2.07Mpa inactive	System blocked, air or water or more refrigerant in system(after repair), water temperature sensor malfunction, ect. Contact a qualified person to service the unit.

P2	High discharge temperature protection Tp>110℃, Protection active Tp<90℃, Protection inactive	System blocked, air or water or less refrigerant(leakage) in system(after repair), water temperature sensor malfunction, ect. Contact a qualified person to service the unit.
P3	Compressor abnormally stopped protection.The discharge temperature is not so higher than evaporator temperature after compressor running a term.	Compressor broken or bad connection between PCB and compressor.Contact a qualified person to service the unit.
P4	Compressor overloaded protection (10 secs after compressor startup, Current checking starts, 1) only compressor running, if it is >10A , the compressor will be stopped and protected.)2) Compressor+e-heater open, if it is >IEH+10,the compressor will be stopped and protected.)	Maybe because of compressor broken, system blocked, air or water or more refrigerant in system(after repair),water temperature sensor malfunction, ect.
LA	When the ambient temp T4 is out of Heat Pump running range (-7~43℃) Heat Pump will stop, unit will show LA on the position of clock on display until T4 back to (-7~43℃). Only valid for the unit without e-heater.Unit with e-heater will never show "LA".	It is normal, and no necessary to repair.

 **NOTE**

- The diagnostic codes listed above are the most common. If a diagnostic code not listed above is displayed, contact residential technical assistance referencing the number on the front of this manual.
- If any of P3/P4/P2/P1 continuously appear 3 times within single heating cycle, the third failure code do not disapper, system will consider it as "Heat Pump system error".Contact a qualified person to service the unit.

- Open the drain port, and release the water, until there are no water flow out of.
- Unscrew anode according to instruction.
- Replace with a new one, and make sure effective sealed.
- Open cold water valve until water flows out from outlet tap, then turn of water outlet tap.
- Power on then restart the unit.
- For the bad mining area environment and poor water quality, it must periodic do the following works base on the actual situations: check the magnesium bar to see whether it has been consumed; clean the sundries in the filter screen to prevent blocking the air inlet; clean the filter screen.

7. MAINTENANCE

7.1 Maintenance

- Check the connection between power supply plug and socket and ground wiring regularly;
- In some cold area (below 0℃), if the system will be stopped for a long time, all the water should be released in case of freezing of inner tank and damage of e-heater.
- It is recommended to clean the inner tank and e-heater every half year to keep an efficient performance.
- Check the anode every half year and change if required. For more details, please contact the supplier or the after-sale service.
- It is recommended to set a lower temperature to decrease the heat release, prevent scale and save energy if the outlet water volume is sufficient.
- Clean the air filter every month in case of any inefficiency on the heating performance.
In terms of the filter set in air inlet directly (namely, air inlet without connect with canvas), the method of dismantle the filter is: anti-clockwise unscrew the air inlet ring, take out the filter and clean it completely, finally, remount it to the unit.
- Before shutting the system down for a long time, please:
Shut down the power supply;
Release all the water in water tank and the pipeline and close all the valves;
Check the inner components regularly.
- How to Change the Anode;
 - Turn off the power, and turn off the water inlet valve.
 - Open hot water tap, and decrease the pressure of the inner container.

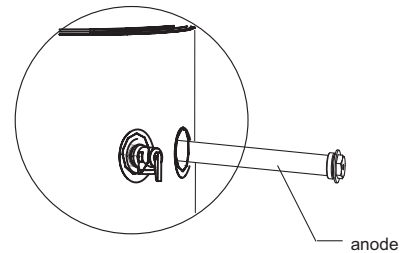

Fig.7-1

7.2 Recommended regular maintenance table

Table. 7-1

Checking Item	Checking content	Checking frequency	Action
1	air filter (inlet/outlet)	every month	Clean the filter
2	anode	every half year	Replace it if it has been used out
3	inner tank	every half year	Clean the tank
4	e-heater	every half year	Clean e-heater
5	PTR valve	every year	Operate the hander of PTR valve to ensure that waterways are clear.
	If water doesn't flow freely when operating the hander, replace PTR valve with a new one		

8. SPECIFICATIONS

Table. 8-1

Model		RSJ-35/300RDN3-D
Water-heating cap.		3000W
Rated power/AMPS		4300W/18.7A
Power supply		220-240V~ 50Hz
Operation control		Auto/Manual startup, error alarm, timer, etc
Protection		High-pressure Protector, Over-load Protector, Temp Controller&Protector, Electric Leakage Protector, etc
E-heater power		3000W
Refrigerant		R134a(1200g)
Water pipeline system	Outlet water temp.	Default 60°C, (38-60°C adjustable)
	Water side exchanger	Safety condenser,copper tube wrapped around outside of storage tank
	Inlet pipe Dia.	DN20
	Outlet pipe Dia.	DN20
	Drain pipe Dia.	DN20
	PTR valve Dia.	DN20
	Max. pressure	1.0MPa
Exchanger air side	Material	Hydrophilic aluminum fin, inner groove copper tube
	Motor power	80W
	Air circulation way	outlet/inlet vertically, water-proof installation available
Dimension		Φ650×2235mm
Water tank cap.		300L
Net weight		117kg
Fusible link type		T30A 250VAC
<p>The test conditions: Ambient temperature 15/12°C(DB/WB), Water temperature from 15°C up to 45°C.</p>		

9. MIDEA– HEAT PUMP MANUFACTURER’S WARRANTY

This warranty is provided by Midea. It applies to heat pumps installed in a single family dwelling only and is provided only to those acquiring the heat pump as consumers within the meaning of the Australian Consumer Law. The terms of the warranty are effective from the date the heat pump is installed. Midea may verify this date by requesting a copy of the compliance certificate that accompanied the installation. The compliance certificate is mandatory in all Australian states and territories.

9.1 Warranty period

Midea warrants that the following heat pump components will remain free of defects for the specified periods from the date of installation:

- Storage Tank- 5 years.
- Compressor- 3 years.
- All other components supplied by Midea, including valves, elements, thermostats and sacrificial anodes - 1 year.
- Midea gives no warranty in relation to components not supplied by Midea, for example tempering valves and cold water valve assemblies used by installers.

Subject to the conditions and exclusions specified in this warranty, Midea will at its own expense repair or replace any defective heat pump component covered by this warranty as soon as reasonably practicable after the consumer has reported the defect to Midea.

9.2 Consumers must register the warranty

To be eligible to make a claim under this warranty, consumers must complete all details in the Installation Report & Warranty Registration form provided with the heat pump within 6 weeks of installation and send it to the address shown on the form.

9.3 Procedure to make a claim under warranty

Upon discovering a suspected defect, consumers should immediately report the suspected defect:

- To the installer or supplier, if the suspected defect arises as a result of the installation of the heat pump or relates to any components not covered by this warranty.
- To Midea on the phone number below during the relevant warranty period, if the suspected defect relates to any components covered by this warranty.

9.4 Specific exclusions

To the extent permitted by law Midea does not accept liability under this warranty:

- 1) If any component of the heat pump has been installed, repaired, repositioned or modified by a person other than an appropriately qualified person approved by Midea in accordance with Midea’s installation and maintenance instructions and relevant local and statutory requirements;
- 2) For loss or damage caused by a fault or defect in the installation of the heat pump;
- 3) If corrosion has occurred because the anode has not been changed in accordance with the owner’s manual;
- 4) If a cold water expansion valve, check valve and strainer is not fitted in areas where mains pressure is likely to exceed 500 kPa;

- 5) For any damage arising as a result of an accident, act of God or other circumstances beyond Midea’s control;
- 6) If the inner cylinder has collapsed as a result of an incorrect filling and/or commissioning procedure;
- 7) For components not supplied by Midea that are used in the installation of Midea heat pump water heaters e.g. tempering valves, cold water valve assemblies, etc.
- 8) For extended or implied warranties not formally provided by Midea;
- 9) For external labour or equipment costs (e.g. cranes and lifting devices) required for repairs;
- 10) For costs incurred for rectifying faults (or perceived faults) not directly attributed to the Midea heat pump water heater;
- 11) For travel costs of service agents that exceed 30 kilometres;
- 12) For all consequential loss or damage arising from defects that can lawfully be excluded;
- 13) For any other issues not directly attributable to defects in components supplied by Midea including:
 - (a) Damage caused by incorrect commissioning;
 - (b) Leakage from valves not supplied by Midea;
 - (c) Leakage from the pressure temperature relief valve where the water pressure or temperature exceeds the limits specified in Midea’s installation and maintenance instructions;
 - (d) Water hammer;
 - (e) External rust on the storage tank;
 - (f) Insufficient hot water because:
 - (i) The consumer refuses to use the auxiliary booster;
 - (ii) Of an incorrectly set or faulty tempering or mixing valve;
 - (iii) Of faulty or incomplete installation;
 - (iv) The water heater is too small for its required purpose;
 - (v) Of insufficient water flow as a result of “water saving” tap-ware or appliances;
 - (vi) Of blown fuses, “tripped” electrical switches or inadequate household electrical wiring;
 - (vii) Insufficient water flow caused by debris accumulating in water strainer.

9.5 Important Note

The benefits conferred by this warranty are in addition to any other rights and remedies available to the consumer under a law in relation to the goods or services to which the warranty relates.

Midea’s goods come with guarantees that cannot be excluded under the Australian Consumer Law. Consumers are entitled to a replacement or refund for a major failure and for compensation for any other reasonably foreseeable loss or damage. Consumers are also entitled to have the goods repaired or replaced if the goods fail to be of acceptable quality and the failure does not amount to a major failure.

Contact Phone: 1300 367 565.

MDV11IU-053FW

202000171853