

Owner's Guide and Installation Instructions



Outdoor Domestic Mains Pressure Gas Storage Water Heater

G270VE Series

*This water heater must be installed and serviced by a qualified person.
Please leave this guide with the householder.*

⚠ Warning: Upon completion of the installation and commissioning of the water heater, leave this guide with the householder or responsible officer. **DO NOT** leave this guide inside the cover of the water heater, as it may interfere with the safe operation of the water heater or ignite when the water heater is turned on.

Patents

This water heater may be protected by one or more patents or registered designs in the name of Aquamax Australia Pty Ltd.

Trademarks

® Registered trademark of Aquamax Australia Pty Ltd.

™ Trademark of Aquamax Australia Pty Ltd.

Note: Every care has been taken to ensure the accuracy in preparation of this publication. No liability can be accepted for any consequences, which may arise as a result of its application.

CONTENTS

Householder: Read the section “About Your Water Heater” (pages 3 to 19). The “Installation” section is intended for the installer but may be of interest.

ABOUT YOUR WATER HEATER	3
Model Type.....	3
Lighting the Water Heater	5
Shut Down Procedure	8
Temperature Adjustment.....	8
Other Important Information	9
Periodic Maintenance.....	11
Water Chemistry.....	14
Troubleshooting	17
INSTALLATION	20
Installation Overview	20
Water Supplies	23
Plumbing & Plumbing Diagrams	24
Plumbing Connections.....	24
Two Temperature Zones Using a Temperature Limiting Device.....	28
Circulated Hot Water Flow & Return Systems	29
Commissioning.....	30
To Fill, Turn ON and Commission the Water Heater	30
Testing Inlet Gas Pressure	31
Testing & Adjusting Burner Gas Pressure.....	32
Draining the Water Heater	34
Dimensions & Technical Data	35
WARRANTY	39

ABOUT YOUR WATER HEATER

Product Application

This water heater is designed for use in a single family domestic dwelling for the purpose of heating potable water. Its use in an application other than this may shorten its life.

⚠ Warning: *This water heater is only intended to be operated by persons who have the experience or knowledge and capabilities to do so. This water heater is not intended to be operated by persons with reduced physical, sensory or mental capabilities i.e. the infirm, or by children. Children should be supervised to ensure they do not interfere with the water heater.*

Model Type

This Aquamax[®] water heater is a 5 star permanent pilot gas storage water heater suitable for outdoor installation only. This water heater is not to be used as a pool heater.

Water is stored in a vitreous enamel storage cylinder and heated by a gas burner located under the cylinder. The heat produced by the burner is transferred to the water through the base, top and side walls of the storage cylinder with flue baffle rings capturing heat to improve efficiency. The gas supply to the burner is controlled by a thermostat so that the water in the storage cylinder is heated and then maintained at a constant temperature. Automatic safety controls are fitted to the water heater to provide safe and efficient operation.

Model Selection Chart

Model Name	G270VE	
	(without mixing valve)	
Model Number	G270VE-NG	G270VE-LP

Note: All models can be supplied with a 'Hard Water Anode'. These models have the suffix 'HWA' at the end of the model number.

Legend

G	Gas Series
270	Rated first hour hot water delivery in Litres
VE	Vitreous enamel storage cylinder
NG	Natural gas
LP	Propane gas

Mains Pressure Operation

This water heater is designed to operate at mains pressure by connecting directly to the mains water supply. If the mains supply pressure in your area exceeds that shown in “Mains Water Supply” on page 23, a pressure limiting valve must be fitted. The supply pressure should be greater than 350 kPa for true mains pressure operation to be achieved.

Hot Water Temperature

This water heater features a user adjustable thermostat located behind the front access panel which controls the temperature of the stored water in the storage cylinder. The thermostat is adjustable between 30 ~ 70°C (factory setting approximately 60°C). Refer to “Temperature Adjustment” on page 8.

To meet the requirements of the National Plumbing Standard, the temperature of the stored water must not be below 60°C.

Note: AS 3498 requires that a water heater provides the means to inhibit the growth of legionella bacteria in stored potable water. This water heater can satisfy this AS 3498 requirement provided it is operating and the thermostat setting is set at 60°C or higher.

High Hot Water Temperature Increases the Risk of Scald Injury

 **Warning:** *This water heater can deliver water at temperatures which can cause scalding. Always check the water temperature before use, such as when entering a shower or filling a bath or basin, to ensure it is suitable for the application and will not cause a scald injury. Aquamax recommends monthly temperature checks to ensure the appropriate temperature is maintained within the hot water heater.*

Aquamax recommends, and it may also be required by regulations, that a secondary device such as an approved temperature limiting device or anti-scald water shut off valve be fitted into the hot water pipe work to the bathroom(s) and ensuite(s) if persons living in the house require additional safety protection from potential scalding. This will keep the hot water supply temperature to the bathroom(s) and ensuite(s) below 50°C which will reduce the risk of scald injury whilst still allowing hotter water (60°C+) to the kitchen and laundry.

For new hot water installations, all sanitary outlet fixtures used primarily for personal hygiene purpose must deliver hot water not exceeding 50°C. This temperature limit is not mandatory for kitchen sinks and laundry tubs and the preferable temperature setting for these outlets should be 60°C.

To minimise scalding, especially for those people in high scald risk categories i.e. young children, people with potentially incapacitating medical conditions, elderly people etc, this water heater must be installed in accordance with AS/NZS 3500.4.

For early childhood centres, primary and secondary schools, nursing homes or similar facilities for young, aged, sick or disabled persons, please consult your local health authority for the correct temperature setting.

Lighting the Water Heater

Safety Warnings

For your safety, read the following warnings before attempting to light the water heater:

 **Warning:** *This water heater is designed to operate reliably and safely as long as the operating instructions are followed **exactly**. You must comply with these lighting instructions at every stage.*

 **Warning:** *Ensure the water heater is filled with water and the water supply is turned on otherwise serious damage to the storage cylinder and water heater components may occur.*

 **Warning:** *After installation and before lighting the water heater, the qualified installer must check all gas connections for leaks. The qualified installer must also test the gas inlet (supply) pressure and burner gas pressure.*

 **Warning:** *Use only your hand to turn the gas knob, never use tools. If the gas knob will not turn by hand, do not try to repair it, call a qualified service technician. Force or attempted repair may cause a fire or dangerous situation.*

 **Warning:** *Do not attempt to operate this water heater if it has been damaged. Call a qualified service technician.*

 **Warning:** *This water heater is equipped with a 'Piezo' push button igniter which lights the pilot. There is no need for matches to light the water heater. When lighting the pilot, follow these instructions exactly.*

Lighting Instructions

1. **Stop.** Read “Safety Warnings” on page 5.
2. Remove single screw retaining access panel and lift out access panel.
3. Slightly depress gas knob and rotate fully clockwise so that the white dot “●” aligns with the gas knob position indicator on the gas control body (off position).
4. **Before lighting:** Ensure there is no smell of gas around vicinity of water heater and burner opening. Be sure to smell next to ground level as some gases can settle there.

If you do not smell gas proceed to step 5.

If you do smell gas do not try to light the water heater. If the gas smell is still present after five minutes, turn off the isolation valve on the gas supply line to the water heater, leave the area and call Aquamax Service or a qualified service technician.

5. Depress gas knob slightly and rotate anticlockwise to the red star “★” (pilot) position.
6. Depress gas knob fully (until red star disappears below housing) and hold in the depressed position. After 20 seconds, whilst keeping gas knob depressed, repeatedly press and release the igniter button for up to 40 seconds or until the pilot flame ignites (igniter is a red button located below and to the right of the gas control).

⚠ Warning: Keep your face clear of combustion chamber opening while operating igniter button.

If pilot ignites, proceed to step 7.

If pilot does not ignite, release gas knob, wait five (5) minutes for any unburnt gas to escape then begin again from the beginning of step 6.

Note: It is not possible to depress the gas knob fully if the gas control has activated its safety shut off feature. In this case, wait 5 minutes for the gas control to reset (this allows for any unburnt gas to escape).

7. Hold gas knob in depressed position for a further 20 seconds and then release.

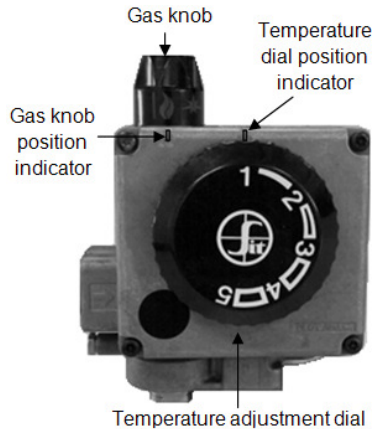

8. Depress gas knob slightly and rotate anticlockwise to the red line “I” (ignition) position and hold in this position for 5 seconds.
9. Release gas knob (gas knob will return to the red flame “🔥” (on) position automatically) and listen for burner noise.
10. If burner ignites, proceed to step 11.

If burner fails to ignite, depress gas knob slightly and rotate gas knob to the white dot “●” (off) position. Wait five (5) minutes for any unburnt gas to escape and then begin again from step 5.

 **Warning:** Failure to wait five (5) minutes may result in a fire or dangerous situation.

11. When the burner remains alight with the gas knob released, rotate temperature adjustment dial so that ‘4’ aligns with the temperature dial position indicator on the gas control body. This is the recommended (and factory default) setting which will provide a water temperature of approximately 60°C. Rotate adjusting dial past this position if a higher temperature is required. Refer to “Temperature Adjustment” on page 8 for dial position indicative temperatures.

Note: To comply with the requirements of AS 3498 and to inhibit the growth of Legionella bacteria, the thermostat setting must be set at 60°C or higher.

 **Warning:** Hotter water increases the risk of scald injury.

12. Replace front access panel.

The main burner will now automatically ignite when heating is required and extinguish when the water in the storage cylinder has been heated to the set temperature. If the main burner does not light at the selected setting, the water may already be at the selected temperature.

Note: Never press igniter button whilst gas knob is in other than the red star “★” (pilot) position.

Shut Down Procedure

To view the gas control components described in this procedure refer to the “Lighting Instructions” diagram on page 6.

1. Remove front access panel by following step 2 of “Lighting Instructions” on page 6.
2. Depress gas knob slightly and rotate gas knob clockwise so that the red star “*” aligns with the gas knob position indicator on the gas control body (pilot position). This setting will leave the pilot flame alight, however the main burner will not be able to ignite.

Note: To reinstate the burner from the red star “*” (pilot) position, depress gas knob slightly and rotate anticlockwise to the red line “I” (ignition) position. Hold in this position for 5 seconds then release the gas knob. The gas knob will return to the red flame “▶” (on) position automatically and the burner will ignite when heating is required and extinguish when the water in the storage cylinder has been heated to the set temperature. If the main burner does not light at the selected setting, the water may already be at the selected temperature.

3. Replace front access panel **or** to completely shut down the gas control, perform steps 4 and 5.
4. Depress gas knob slightly and rotate clockwise to the white dot “●” (off) position. This setting shuts the gas control down completely.

Note: To reinstate the gas control and burner from the white dot “●” (off) position, follow the “Lighting Instructions” on page 6.

5. Replace front access panel.

Note: When switched back on from the red star “*” (pilot) position or white dot “●” (off) position, the water heater may take up to an hour to reheat.

Temperature Adjustment

 **Warning:** AS 3498 requires that a water heater provides the means to inhibit the growth of *Legionella* bacteria in potable water. This water heater can satisfy this AS 3498 requirement provided it is operating and the thermostat setting is 60 °C or higher.

Thermostat Adjustment – All Models

The thermostat controls the stored water temperature.

The thermostat automatically controls the gas supply to the burner so that a constant water temperature is maintained within the storage cylinder. The thermostat is fully automatic and the burner only operates when the water

in the storage cylinder requires heating. There is no need to switch the water heater off when it is not in use, except when you are going away for an extended period.

The temperature adjustment dial is on the front of the gas control located behind the front access panel of the water heater (refer to the diagram in “Lighting Instructions” on page 6). The adjustment dial is marked with numerals with each number representing a temperature difference of approximately 10°C. When aligned with the temperature dial position indicator on the gas control body, the dial setting corresponds approximately to the following temperatures:

Dial Setting	1	2	3	4	5
Temperature	30°C	40°C	50°C	60°C	70°C

To adjust the thermostat:

1. Remove front access panel by following step 2 of “Lighting Instructions” on page 6.
2. Rotate temperature adjustment dial anticlockwise to increase or clockwise to decrease the stored water temperature.

 **Warning:** Hotter water increases the risk of scald injury.

3. Replace front access panel.

Other Important Information

Going Away?

If you plan to be away from home for one or two nights, we suggest you leave the water heater switched on. However, if you plan to stay away more than a few nights, the gas knob can be set to the red star “★” (pilot) position to conserve energy (follow steps 1~ 3 of “Shut Down Procedure” on page 8).

Note: When switched back on, the water heater may take up to an hour to reheat.

Safety

This water heater is supplied with a thermostat, an over temperature cut out, a thermocouple and a combination pressure temperature relief valve. These devices must not be tampered with or removed. The water heater must not be operated unless each of these devices are fitted and are in working order.

The Aquamax warranty may not cover faults if relief valves or other safety devices are tampered with or if the installation is not in accordance with these instructions.

 **Warning:** For continued safety of this water heater, it must be installed, operated and maintained in accordance with the Owner's Guide and Installation Instructions. These instructions must be read in conjunction with all other instructions affixed to the appliance.

 **Warning:** Do not store **flammable or combustible materials** near the water heater. Flammable liquids (such as petrol), newspapers and similar articles must be kept well away from the water heater and the flue terminal.

 **Warning:** Do not use **aerosols, stain removers and household chemicals** near the water heater whilst it is operating. Gases from some aerosol sprays, stain removers and household chemicals are flammable and/or become corrosive when drawn into a flame.

 **Warning:** Do not store **swimming pool chemicals, household cleaners, etc.**, near the water heater.

 **Warning:** Do not place anything in contact with the flue terminal. Ensure the flue terminal is not obstructed in any way at any time.

How Long Will the Water Heater Last

The water heater is supported by a manufacturer's warranty (refer to page 39). There are a number of factors that will affect the length of service the water heater will provide. These include but are not limited to the water chemistry, the water pressure, the water temperature (inlet and outlet) and the water usage pattern.

Precautions

Where damage to property can occur in the event of the water heater leaking, the water heater must be installed in a safe tray. Construction, installation and draining of a safe tray must comply with AS/NZS 3500.4 and all local codes and regulatory authority requirements.

The water heater must be maintained in accordance with the Owner's Guide and Installation Instructions. Refer to "Periodic Maintenance" on page 11.

If this water heater is to be used where an uninterrupted hot water supply is necessary for your application or business, you should ensure that you have back up redundancy within the hot water system design. This should ensure the continuity of hot water supply in the event that this water heater

was to become inoperable for any reason. We recommend you seek advice from your plumber or specifier about your needs and building back up redundancy into your hot water supply system.

Periodic Maintenance

Minor Six Monthly Maintenance

It is recommended minor maintenance be performed every six months by the dwelling occupant.

 **Warning:** *Exercise care when operating easing levers as water discharged from the water heater may be of a very high temperature.*

Minor maintenance actions:

1. Operate easing lever on pressure temperature relief valve (refer to “Pressure Temperature Relief Valve” on page 12).
2. Operate easing lever on expansion control valve (if ECV fitted) (refer to “Expansion Control Valve” on page 13).
3. If a safety tray is installed, check to ensure the safety tray drain pipe is not blocked.

Annual Service

It is recommended an annual service be conducted on the water heater. Servicing must be performed by a qualified person. Phone Aquamax Service or their nearest Accredited Service Agent.

Annual service actions:

1. Inspect and flush temperature pressure relief valve.
2. Inspect and flush expansion control valve (if ECV fitted).
3. Check and if necessary adjust burner gas pressure.
4. Check piezo igniter, gas control and thermocouple condition and operation.
5. Check operation of and clean pilot and main burner.
6. Visually check the water heater for any potential problems.
7. Inspect all plumbing, gas and electrical connections.

Note: The water heater may need to be drained during this service and may take up to an hour to reheat the water after servicing has been completed.

Major Five Year Service

It is recommended a major five year service be conducted on the water heater. Servicing must be performed by a qualified person. Phone Aquamax Service or their nearest Accredited Service Agent.

Note: The five year service and routine replacement of any components, such as the relief valve(s), are not included in the Aquamax warranty. A charge will be made for this work.

Major five year service actions:

1. Replace pressure temperature relief valve.
2. Inspect and flush expansion control valve (if ECV fitted) and replace expansion control valve if required.
3. Inspect anode and replace anode if required. If the anode is not replaced, it should be replaced within three years of this service. Refer to "Anode" on page 13.
4. Check and if necessary adjust burner gas pressure.
5. Check piezo igniter, gas control and thermocouple condition and operation.
6. Check operation of and clean pilot and main burner.
7. Visually check the water heater for any potential problems.
8. Inspect all plumbing and gas connections.

Note: The water heater may need to be drained during this service and may take up to an hour to reheat the water after servicing has been completed.

Pressure Temperature Relief Valve (PTR Valve)

The PTR valve is near the top of the water heater and is essential for safe water heater operation. It is possible for the PTR valve to release a little water through the drain line during each heating period. This occurs as the water is heated and expands by approximately 1/50 of its volume.

Continuous leakage of water from the PTR valve and its drain line may indicate a problem with the water heater (refer to "Pressure Temperature Relief Valve Running" on page 18).

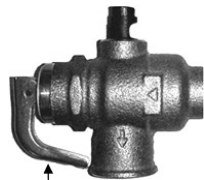



Easing lever

⚠ Warning: Never block the outlet of the PTR valve or its drain line for any reason.

Operate the easing lever on the PTR valve once every six months. **It is very important you raise and lower the lever gently.**

 **Warning:** Exercise care when operating easing lever as water discharged from the water heater may be of a very high temperature.

 **Warning:** Exercise care to avoid any splashing of water, as water discharged from the drain line will be hot. Stand clear of the drain line's point of discharge when operating the valve's lever.

 **Danger:** Failure to perform this procedure may result in the water heater storage cylinder failing, or under certain circumstances, exploding.

If water does not flow freely from the drain line when the lever is lifted, then the water heater must be checked. Phone Aquamax Service or their nearest Accredited Service Agent to arrange for an inspection.

The pressure temperature relief valve should be replaced at intervals not exceeding 5 years, or more frequently in areas where there is a high incidence of water deposits (refer to "Water Chemistry" on page 14).

Expansion Control Valve (ECV)

In many areas, including South Australia, Western Australia and scaling water areas, an ECV is fitted to the cold water supply line to the water heater (refer to the "Cold Water Supply Plumbing Arrangement" diagram on page 25). The ECV may discharge a small quantity of water from its drain line during the heating period instead of the PTR valve on the water heater.

Operate the easing lever on the expansion control valve once every six months. ***It is very important that you raise and lower the lever gently.***

The expansion control valve should be checked for performance or replaced at intervals not exceeding 5 years, or more frequently in areas where there is a high incidence of water deposits (refer to "Water Chemistry" on page 14).

Anode

The anode installed in your water heater has been designed to slowly dissipate whilst protecting the storage cylinder. If the hot water heater is not used for two (2) weeks or more, a quantity of hydrogen gas, which is highly flammable, may accumulate in the water heater. To dissipate this gas safely, it is recommended that a hot tap be turned on for several minutes or until discharge of gas ceases. Use a sink, basin, or bath outlet, but not a dishwasher, clothes washer or other appliance. During this procedure, there must be no smoking, open flame, or any electrical appliances operating nearby. If hydrogen is discharged through the tap, it will probably make an unusual sound similar to air escaping.

The life of the storage cylinder may be extended by arranging a qualified person to periodically inspect the anode and replace if required. If the anode is not replaced during a five year service (refer to “Major Five Year Service” on page 12) then the maximum time after installation when the anode should be replaced for this electric water heater is 8 years.

For water supplies which are either softened, desalinated or where the water supply may alternate between a water tank and a reticulated public supply or another supply, it is recommended the anode be replaced within 5 years of installation.

Change of Water Supply

The changing or alternating from one water supply to another can have a detrimental effect on the operation and / or life expectation of the water heater storage cylinder, pressure temperature relief valve and heating unit.

Where there is a changeover from one water supply to another, e.g. a rainwater tank supply, bore water supply, desalinated water supply, public reticulated water supply or water brought in from another supply, then water chemistry information should be sought from the supplier or it should be tested to ensure the water supply meets the requirements given in these guidelines for the Aquamax warranty to apply.

Water Chemistry

This water heater must be installed in accordance with this advice to be covered by the Aquamax warranty.

This water heater is manufactured to suit the water conditions of most public reticulated water supplies. However, there are some known water chemistries which can have detrimental effects on the water heater and its operation and / or life expectancy. If you are unsure of your water chemistry, you may be able to obtain information from your local water supply authority. This water heater should only be connected to a water supply which complies with these guidelines for the Aquamax warranty to apply.

Total Dissolved Solids (TDS)

Some water analysis reports may state the conductivity of the water rather than the level of total dissolved solids. Conductivity, measured in microsiemens per centimetre ($\mu\text{S} / \text{cm}$), is directly proportional to the TDS content of the water. TDS, in mg/L, is approximately 70% of the conductivity in $\mu\text{S} / \text{cm}$.

The Aquamax warranty will not cover resultant faults to the storage cylinder if this water heater is connected at anytime to a water supply where the TDS content of the water exceeds 600 mg/L.

In locations where TDS approaches 600 mg/L, e.g. due to sediment, we strongly recommend fitting an appropriate filter to ensure water entering or in the water heater does not exceed this level at any time i.e. due to sediment build up.

Water Chemistry & Anode Type

Aquamax water heaters are designed to suit the water conditions of most metropolitan supplies, where the Total Dissolved Solids (TDS) content of the supply is less than 600 mg/Litre. For use in regions where the water supply TDS exceeds 600 mg/Litre, the magnesium alloy anode (supplied as standard, cap colour code 'Black') may become excessively reactive. For safety reasons and the longevity of the anode, the magnesium anode should be replaced with an aluminium alloy anode (cap colour code 'Blue') available from your Aquamax supplier. Anode replacement must be carried out by an Aquamax accredited service agent.

 **Warning:** *If the water supply has a TDS greater than 600 mg/L and the anode has not been changed to a blue anode, there is the possibility the anode may become overactive and hydrogen gas could accumulate in the top of the water heater during long periods of no use.*

If the water heater has not been used for two or more weeks, follow the procedure detailed in the "Anode" section on page 13 for safe dissipation of the hydrogen gas build up inside the storage cylinder.

It must be noted that in areas where the TDS exceeds 600 mg/Litre, the Aquamax warranty will not cover resultant faults on components including the storage cylinder that fail due to the bad water conditions even though an aluminium anode is fitted. Refer to "Water Chemistry Levels Affecting Warranty" on page 16 for water chemistry levels and components affected.

The life of the water heater will also be extended by periodic inspection of the anode and replacement if necessary (refer to "Periodic Maintenance" on page 11 and "Anode" on page 13).

Water Chemistry Levels Affecting Warranty

The Aquamax warranty of this water heater will not cover resultant faults on components including the storage cylinder where water stored in the storage cylinder exceeds at any time any of the following levels:

Total dissolved solids	600 mg/Litre
Total hardness	200 mg/Litre
Chloride	300 mg/Litre
Magnesium	10 mg/Litre
pH	9.5 and not less than 6.5
Calcium	20 mg/Litre
Sodium	150 mg/Litre
Iron	1 mg/Litre

Scaling Water

Scaling water is water that contains levels of calcium carbonate (total hardness in excess of 200 mg/Litre at any time when the water heater is operating). Scaling water can block and prevent the pressure & temperature relief valve from operating resulting in damage to the water heater storage cylinder and water heater components.

An expansion control valve is mandatory in SA & WA and must be fitted in ALL areas with scaling water to assist in preventing blockage of the pressure and temperature relief valve.

 *Danger:* Failure to install an expansion control valve where scaling water conditions occur may result in the water heater storage cylinder failing, or under certain circumstances, exploding.

To avoid damage to the storage cylinder and water heater components, Aquamax strongly recommend scaling water be treated before entering the water heater by fitting appropriate water filters/conditioners etc. Refer to your Local Water Authority for information on water in your area. A build up of white sediment on hot water taps or shower roses can be indicative of scaling water. Contact Aquamax if this condition is observed.

Note: Damage caused by scaling water can affect the Aquamax warranty. (Refer to “Water Chemistry Levels Affecting Warranty” on page 16).

Spring, Dam, Bore & River Water Supplies

The Aquamax warranty of this water heater will not cover resultant faults on components including the storage cylinder due to the effects of sludge and/or sediment as a result of connection to a water supply from silted or treated sources i.e. springs, dams, bores, rivers or towns supplied from a bore.

Troubleshooting

Check the items below before making a service call. If the water heater is within the warranty period you will be charged for attending to any condition or fault that is not related to the manufacture or failure of a part. For warranty terms and conditions (refer to “Warranty” on page 39).

Not Enough Hot Water (Or No Hot Water)

- *Is a pilot flame present?*

Remove the front access panel and check that a pilot flame is present. If the pilot flame is not burning relight the heater by following the “Lighting Instructions” on page 6.

- *Are you using more hot water than you think?*

Is one outlet (especially the shower) using more hot water than you think? Very often the amount of hot water used is not realised, particularly when showering. Carefully review the family’s hot water usage. Have your plumber fit a flow control valve to each shower outlet to reduce water usage.

- *Pressure temperature relief valve running?*

Is the PTR valve discharging too much water? (Refer to “Pressure Temperature Relief Valve Running” on page 18).

- *Is the thermostat setting appropriate?*

Ensure the thermostat setting is appropriate. You may choose to adjust the thermostat upwards to gain additional hot water capacity. Refer to “Temperature Adjustment” on page 8.

 **Warning:** Hotter water increases the risk of scald injury.

Water Not Hot Enough

- *Has your hot water usage increased?*

You may find that due to heavy hot water usage the water temperature may be lower than normally expected.

- *Is the thermostat setting correct?*

Ensure the thermostat setting is correct. Refer to “Temperature Adjustment” on page 8.

Pressure Temperature Relief Valve Running

- *Normal Operation*

It is normal and desirable for the PTR valve to allow a small quantity of water to escape during the heating cycle, however there may be a problem if the valve continuously dribbles more than a bucket full of water in a normal 24 hr cycle.

- *Continuous dribble*

Try gently raising the easing lever on the relief valve for a few seconds (refer to “Pressure Temperature Relief Valve” on page 12). This may dislodge a small particle of foreign matter and clear the fault. Release the lever gently.

- *Steady flows for long period (often at night)*

This may indicate the mains water pressure sometimes rises above the designed pressure of the water heater. Ask your installing plumber to fit a pressure limiting valve.

 **Warning:** *Never use reconditioned relief valves and never replace the relief valve with one of a higher pressure rating.*

Expansion Control Valve Running

If an expansion control valve is fitted in the cold water supply line to the water heater, it may discharge a small quantity of water instead of the water heaters pressure temperature relief valve. This has the benefit of conserving energy as the discharged water is cooler (refer to the “Cold Water Supply Plumbing Arrangement” diagram on page 25 for expansion control valve location).

Can't Light the Pilot

- *Is there gas to the water heater?*

Check to ensure the gas isolation valve on the gas supply line to the water heater is open.

- *Is there a normal gas supply to the rest of the premises?*

Try lighting another gas appliance to check if there is a normal gas supply present. If there is no gas, call the gas supplier.

Water Heater appears to be Leaking

When the water heater is first lit, or after a large usage of hot water, condensation may form on and drip from the grille at the front of the water heater. During periods of heavy condensation, condensate may also form

around the base of the water heater. This is quite normal, especially in winter months and the condensate will dry off as the water is heated.

The water heater will drip water during the heating cycle. It is possible for several litres a day of condensation to discharge from the unit, especially in cool conditions. This water is not from the mains supply but is condensation from the atmosphere caused by the efficient operation of the water heater.

Note: During the heating cycle it is not unusual to see water vapour clouds steaming from the flue terminal. This is normal operation.

Higher Than Expected Gas Bills

Check the following points if your gas bill is higher than expected:

- *Is the relief valve running excessively?*
Refer to “Pressure Temperature Relief Valve Running” on page 18.
- *Is one outlet (especially the shower) using more hot water than you think?*
Refer to “Not Enough Hot Water” on page 17.
- *Is there a leaking hot water pipe, dripping hot water tap, etc?*
Even a small leak will waste a surprising quantity of hot water and gas. Replace faulty tap washers and have your plumber rectify any leaks.
- *Has there been an increase in hot water usage?*
An increase in hot water usage will result in an increase in water heater operation.
- *Has your gas rate been increased by your gas retailer since your previous bill?*
Check your previous bill and compare gas rates and charges.

If you have checked all the previous troubleshooting points and still believe you need assistance, phone Aquamax Service or their nearest Accredited Service Agent.

INSTALLATION

Installation Overview

This water heater must be installed by a qualified person in accordance with the installation instructions. The installation must comply with the requirements of AS/NZS 3500.4, AS 5601 or AS/NZS 5601.1, all local codes and regulatory authority requirements.

Check to ensure the water heater is suitable for the gas type available (refer to the water heaters rating label).

All packaging materials must be removed from the water heater prior to its installation. This includes the removal of the cardboard base of the carton from the underside of the water heater.

This water heater is not suitable for pool heating.

Hot Water Redundancy

If this water heater is to be used where an uninterrupted hot water supply is necessary for the application or business, then there should be redundancy within the hot water system design. This should ensure the continuity of hot water supply in the event that this water heater was to become inoperable for any reason. We recommend you provide advice to the system owner about their needs and building backup redundancy into the hot water supply system.

Water Heater Location

This water heater is suitable for outdoor installation only. The water heater should be installed close to the most frequently used outlet and its position chosen with safety and service in mind.

Ensure people, particularly children, will not touch the flue outlet. The flue terminal must be clear of obstructions including shrubbery.

Sufficient and safe space for ease of service and access to front access cover, burner and relief valve should be considered when locating the water heater. The water heater must be installed upright in a vertical position and must be accessible without the use of a ladder or scaffold. If adequate room is unavailable, the water heater must be disconnected, drained and removed to enable servicing.

The water heater should be installed at ground level on a fire proof base, such as a concrete or brick plinth, as approved by the local authority. The water heater must stand vertically upright with the back of the water heater **against an external wall**. Failure to observe this precaution can cause problems in high wind areas. A secondary flue is not required.

It is a requirement of AS 5601 and AS/NZS 5601.1 that the water heater is secured to a wall. A wall bracket is supplied with the water heater for this purpose. The top of the unit is to be secured to the wall using the wall bracket and masonry anchor provided (or other suitable fastener). Refer to “Wall Bracket Installation” on page 22.

Note: Damage to the storage cylinder caused by incorrect installation is not covered by warranty.

This water heater must not be installed in an area with a corrosive atmosphere where chemicals are stored or where aerosol propellants are released. Remember the air may be safe to breathe, but when it goes through a flame, chemical changes take place which may attack the water heater. Some chemicals and aerosol propellants are flammable and storing or using these products near the water heater may cause fire or explosion.

The following restrictions to water heater location are from AS 5601 or AS/NZS 5601.1 and are supplied here as a guide. The dimensions shown in the table below are the minimum clearance distances from the flue terminal. These clearances must be observed at all times.

Below eaves balconies and other projections	300
From the ground, above a balcony or other surface	300
From a return wall or corner. Refer example (a) in diagram	500
From a gas meter	1000
From an electricity meter box or fuse box	500
From a drain pipe or soil pipe	150
Horizontally from any building structure or obstruction facing a terminal	500
From any other flue terminal, cowl or combustion air intake	500
Horizontally from an openable window, door, non mechanical air inlet, or any other opening into a building with the exception of sub floor ventilation. Refer example (b) in diagram	500
From a mechanical air inlet, including a spa blower	1500
Vertically below an openable window, non mechanical air inlet, or any other opening into a building with the exception of sub floor ventilation. Refer example (c) in diagram	500
From any other combustible material	500

All dimensions in mm.

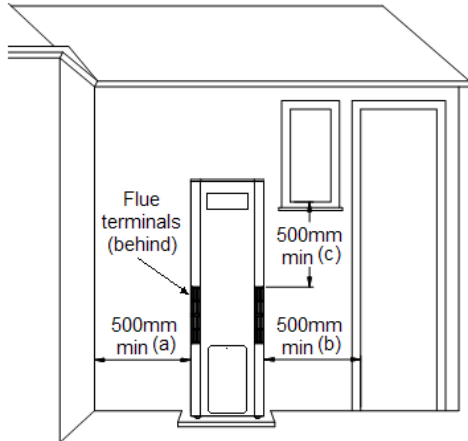

Examples a, b & c from previous table

Wall Bracket Installation

It is a requirement of AS 5601 and AS/NZS 5601.1 that water heater is secured to a wall. The top of the water heater is to be secured to the wall using the wall bracket and M6.5 masonry anchor provided with the water heater (or other suitable fastener). It is necessary to fix the bracket to the wall after positioning the water heater but prior to making the water and gas connections.

To install the wall bracket:

1. Position water heater.
2. Slide wall bracket into formed slot at top rear of water heater. Ensure angled profile is facing wall.
3. Mark wall where hole is to be drilled.
4. Remove bracket.
5. Drill hole to receive the M6.5 masonry anchor (or other suitable fastener).
6. Replace wall bracket with angled profile facing wall.
7. Secure wall bracket to wall.

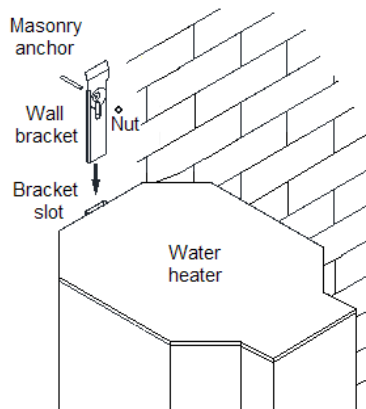

Safe Tray

Where damage to property can occur in the event of the water heater leaking, the water heater must be installed in a safe tray. Construction, installation and draining of a safe tray must comply with AS/NZS 3500.4 and all local codes and regulatory authority requirements. AS/NZS 3500.4 also has particular requirements when a safe tray must be installed.

Flashing Kit

When attaching a Flashing Kit to the water heater jacket, we recommend the use of self-drilling screws with a maximum length of 12 mm. An effective seal must be achieved where the screw penetrates the jacket. The Flashing Kit must not be installed within a 100 mm wide vertical strip either side of the cold water inlet, hot water outlet and pressure temperature relief valve. Flashing Kits are available from Aquamax and if required are purchased as a separate kit. The kit part number is:

Model	G270VE
Flashing Kit Part No.	AQ1184105

Note: If the water heater or storage cylinder is damaged as a result of installing the Flashing Kit, any resultant faults will not be covered by the Aquamax warranty.

Water Supplies

Mains Water Supply

Where the mains water supply pressure exceeds that shown in the table below, an approved pressure limiting valve is required and should be fitted after the stop cock and before the non return valve as shown in the “Cold Water Supply Plumbing Arrangement” diagram on page 25.

Model		G270VE
Pressure temperature relief valve setting		1400 kPa
Expansion control valve (ECV) setting *		1200 kPa
Max mains supply pressure	With ECV	960 kPa
	Without ECV	1120 kPa

* Expansion control valve not supplied with water heater.

Tank Water Supply

If the water heater is supplied with water from a tank supply and a pressure pump system is not installed, then the bottom of the supply tank must be at least 1 m above the highest point of the hot water plumbing system,

including the water heater. Care must be taken to avoid air locks. The cold water supply line to the water heater must be adequately sized and fitted with an approved full flow gate valve or ball valve and non return valve.

Water Supply Chemistry

Bad water can have a detrimental effect on water heater operation, components and life expectancy and may affect warranty. Refer to “Water Chemistry” on page 14 for more information. Also refer to “Spring, Dam, Bore & River Water Supplies” on page 16.

Plumbing & Plumbing Diagrams

Plumbing Connections

All pipe work must be cleared of foreign matter before connection and purged before attempting to operate the water heater. Use thread sealing tape or an approved thread sealant on all fittings (never use hemp).

All Aquamax storage cylinder water fittings have a plastic liner fitted. These liners must be in place for the water heater to function properly. All liners are correctly positioned during manufacture and should not require handling during installation, however if a liner is not correctly inserted or aligned, it should be gently pushed back into place before connecting any plumbing fittings.

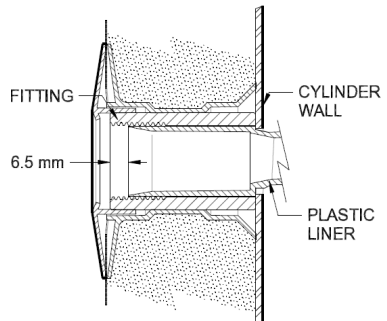

⚠ Warning: Plastic liners must be in place for the water heater to function properly. Do not remove or damage liners.

⚠ Warning: Do not use heat near plastic liners. Heat can be transferred by conduction which may damage liners.

Gas Inlet Connection

The gas inlet connection is made through the left hand side of the water heater near the front access panel. Gas pipe work must be cleared of foreign matter before connection and purged before attempting to light the water heater. A gas isolation valve and disconnection union must be installed to allow servicing and removal of the water heater.

Refer to AS 5601 or AS/NZS 5601.1 for the correct method of sizing the gas supply pipe work to the water heater. Pipe size selection must take into account the gas input of this water heater (refer to “Dimensions & Technical

Data” on page 35) as well as the gas input of all other gas appliances in the premises.

Natural Gas Models: Remove yellow warning label from gas control after connecting gas supply line.

Propane Gas Models: A gas regulator is supplied with the water heater and must be installed externally between the gas isolation valve and jacket of the water heater. Refer to gas flow directional arrow on regulator body to ensure it is installed in the correct orientation. The regulator has been factory preset and is non adjustable.

⚠ Warning: Always isolate the water heater before pressure testing the gas supply system. Disconnect water heater after isolating valve to prevent the risk of serious damage to the gas control. The Aquamax warranty does not cover damage of any nature resulting from failure to observe this precaution. Refer to water heaters rating label for gas pressures.

⚠ Warning: Care is necessary when tightening fittings into gas control as the gas control casting may crack if fittings are over tightened. Cracked control castings are not covered under the Aquamax warranty. A Damaged gas control must be replaced.

Water Inlet & Outlet Connections

An approved isolation valve and non return valve must be installed in the supply line to the water heater.

A pressure limiting valve and expansion control valve may also be required (for PLV requirements refer to “Water Supplies” on page 23 and for ECV requirements refer to “Expansion Control Valve” on page 26).

A disconnection union must always be provided at the cold water inlet and hot water outlet of the water heater to allow for water heater disconnection.

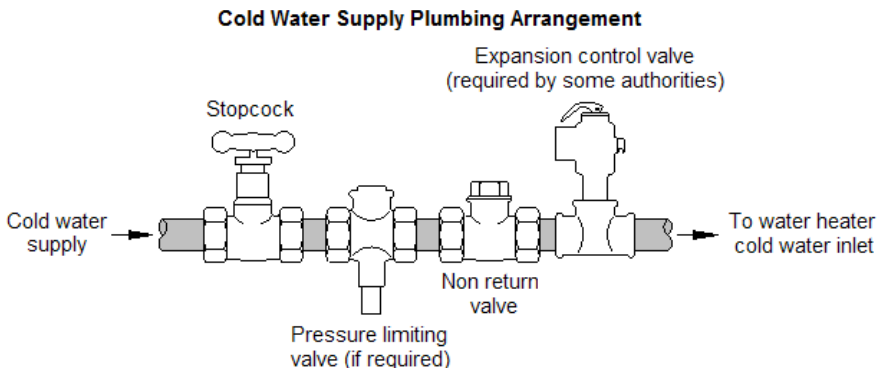

Expansion Control Valve

In some areas, local regulations may make it mandatory to install an expansion control valve (ECV) in the cold water line to the water heater. Refer to “Scaling Water” on page 16.

The ECV must always be installed after the non return valve and be the last valve installed prior to the water heater (refer to the “Cold Water Supply Plumbing Arrangement” diagram on page 25). A copper drain line must be fitted to the ECV (refer to “Relief Valve Drain(s)” on page 26).

Pressure Temperature Relief Valve

The pressure temperature relief (PTR) valve must be fitted before the water heater is operated. Before fitting the PTR valve, make sure the valve probe has not been bent. Seal the valve thread with thread sealing tape (never use hemp) and ensure the tape does protrude past the end of the thread.

Screw the valve clockwise into the right hand side opening on the water heater marked “PTR” (refer to diagram on page 35) with the valve outlet pointing downwards. Do not use a wrench on the valve body – use a spanner on the spanner flats. A copper drain line must be fitted to the PTR valve (refer to “Relief Valve Drain(s)” on page 26).

The valve is supplied with an insulation collar. This must not be removed. The valve must be insulated with closed cell polymer insulation or similar (minimum thickness 9 mm) and the insulation installed so as not to impede the operation of the valve. The insulation must be weatherproof and UV resistant if exposed.

Relief Valve Drain(s)

DN15 copper drain lines must be fitted to the pressure temperature relief valve and expansion control valve (if one is installed) to carry the discharge clear of the water heater. Connect the drain lines to the valves using disconnection unions. The drain line from the valve to the point of discharge should be as short as possible, have a continuous fall all the way from the water heater to the discharge outlet and have no tap, valves or other restrictions in the pipe work. A drain line from a relief valve must comply with the requirements of AS/NZS 3500.4.

A drain line must be no longer than 9 metres with no more than three bends greater than 45° before discharging at an outlet or air break. The maximum length of 9 metres for a drain line is reduced by 1 metre for each additional bend required of greater than 45°, up to a maximum of three additional bends. Where the distance to the point of final discharge exceeds this length, the drain line can discharge into a tundish.

Subject to local regulatory authority approval, the drain lines from the pressure temperature relief valve and expansion control valve from an individual water heater may be interconnected.

The outlet of a drain line must be in such a position that flow out of the pipe can be easily seen, but arranged so discharge will not cause injury, damage or nuisance. The termination point of a drain line must comply with the requirements of AS/NZS 3500.4. Drain lines must not discharge into a safe tray.

In locations where water pipes are prone to freezing, drain lines must be insulated, must not exceed 300mm in length and are to discharge into a tundish through an air gap of between 75mm and 150mm.

If a drain line discharges into a tundish, the drain line from the tundish must be not less than DN20. The drain line from a tundish must meet the same requirements as for a drain line from a relief valve.

 **Warning:** *As the function of the pressure temperature relief valve on this water heater is to discharge high temperature water under certain conditions, it is strongly recommended the pipe work downstream of the relief valve be capable of carrying water exceeding 93°C. Failure to observe this precaution may result in damage to pipe work and property.*

Pipe sizes

To achieve true mains pressure operation, the cold water line to the water heater should be the same size or larger than the hot water line from the water heater.

Hot water system pipe work must be sized according to the individual application by persons competent to do so. Reference to the technical specifications of the water heater and local regulatory authority requirements must be made.

Pipe Work Insulation

To reduce heat loss, the cold water line to and the hot water line from the water heater must be insulated in accordance with the requirements of AS/NZS 3500.4. The insulation must be weatherproof and UV resistant if exposed.

Saddling Pipe Work

To prevent damage to the storage cylinder it is not permissible to drill through the jacket of the water heater except when attaching a Flashing Kit. Refer to "Flashing Kit" on page 23. **Note:** If the water heater or storage cylinder is damaged as a result of installing a Flashing Kit, any resultant faults will not be covered by the Aquamax warranty.

Two Temperature Zones Using a Temperature Limiting Device

This water heater can deliver water at temperatures which can cause scalding. It is necessary and we recommend that a temperature limiting device be fitted between the water heater and the hot water outlets in any abluion area such as a bathroom or ensuite, to reduce the risk of scalding.

The installing plumber may have a legal obligation to ensure the installation of this water heater meets the delivery water temperature requirements of AS/NZS 3500.4 so that scalding water temperatures are not delivered to a bathroom, ensuite or other abluion area.

Where a temperature limiting device is installed adjacent to the water heater, the cold water line to the temperature limiting device can be branched off the cold water line either before or after the isolation valve, pressure limiting valve and non return valve to the water heater. If an expansion control valve is required, it must always be installed after the non return valve and be the last valve prior to the water heater.

If a pressure limiting valve is installed on the cold water line to the water heater and the cold water line to a temperature limiting device branches off before this valve or from another cold water line in the premises, then a pressure limiting valve of an equal pressure setting may be required prior to the temperature limiting device.

Two Temperature Zone Plumbing Diagram

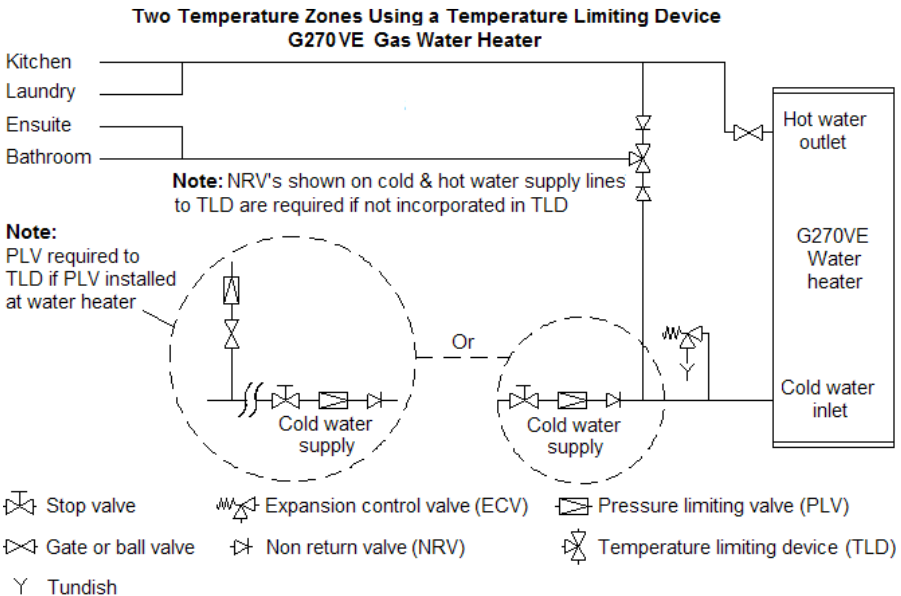

Circulated Hot Water Flow & Return Systems

For circulated hot water flow and return systems, a temperature limiting device can only be installed on a dead leg which branches off the circulated hot water flow and return pipe.

⚠ Warning: *Installing a temperature limiting device in the circulated flow and return pipe work, or circulating tempered water from a temperature limiting device may cause water to be delivered to ablution areas at a temperature exceeding the requirements of AS/NZS 3500.4.*

Circulated Hot Water Flow & Return Plumbing Diagram

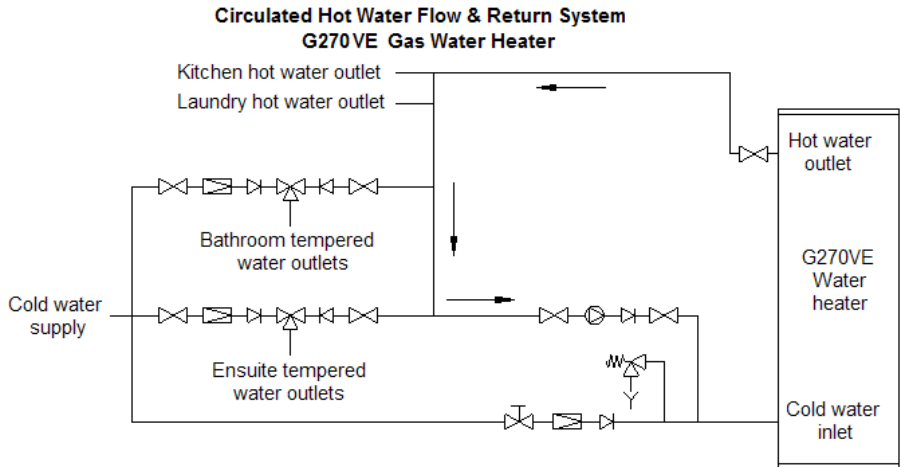

⊞ Stop valve

⊞ Expansion control valve (ECV)

⊞ Pressure limiting valve (PLV)

⊞ Gate or ball valve

⊞ Non return valve (NRV)

⊞ Temperature limiting device (TLD)

⊞ Circulating pump

Y Tundish

Note: NRV's shown on cold & hot water supply lines to TLD's are required if not incorporated in TLD

Commissioning

To Fill, Turn ON and Commission the Water Heater

 **Warning:** *The pilot or burner must not be lit until the water heater is filled with water.*

1. Open all hot water taps in premises including shower(s).
2. Fully open cold water isolation valve on cold water line to water heater. This will purge air from hot water plumbing lines via taps opened in step 1.
3. Close each hot water tap after all air is purged (when air is purged water will run freely without air bubbles or spluttering).
4. Check all plumbing connections for leaks.
5. Fully open gas isolation valve on gas supply line to water heater.
6. Check all gas connections for leaks using a soapy water solution.
7. Test inlet gas pressure (refer to "Testing Inlet Gas Pressure" on page 31).
8. Test gas burner pressure and adjust if required (refer to "Testing & Adjusting Burner Gas Pressure" on page 32).
9. Light the water heater (refer to "Lighting Instructions" on page 6).
10. Test water heater operation. Water heater operation must be thoroughly checked as follows:
 - The pilot should burn with a small blue flame. A luminous yellow or "floating" flame is not acceptable.
 - The burner flame must light smoothly and quickly from the pilot flame, and must go out quietly and completely.
 - The main burner flame must be stable, although slight lifting at the front edge of the burner is acceptable when the burner is cold.
 - The main burner flame should be blue, with a clearly defined inner cone. Luminous yellow or "floating" flames are not acceptable.
 - If unable to get the water heater working properly, contact Aquamax Service or their nearest Accredited Service Agent.
11. Replace front access panel.

Explain to the householder, or a responsible officer, the functions and operation of the water heater.

Leave this guide with the householder or responsible officer upon completion of the installation and after commissioning.

⚠ Warning: DO NOT leave this guide inside the water heater as it may interfere with the safe operation of the water heater or ignite when the water heater is turned on.

To Turn OFF the Water Heater

Sometimes it is necessary to turn off the water heater after installation and commissioning. This may be required on a building site or where the premises are vacant. To turn off the water heater refer to “Shut Down Procedure” on page 8.

Testing Inlet Gas Pressure

The inlet gas pressure (gas supply pressure) to the water heater must be checked as part of the commissioning procedure. The inlet gas pressure must be checked with all other gas appliances in the premises operating (burners alight). The minimum gas pressure is 1.13 kPa for natural gas and 2.75 kPa (-5% tolerance) for propane gas. The maximum gas pressure is 3.5 kPa for both gas types.

If the gas pressure is below the minimum for the relevant gas type, it may indicate the gas supply meter or the gas line to the water heater is undersized.

If the gas pressure is above the maximum for the relevant gas type, a gas regulator will need to be installed on the gas line to the water heater.

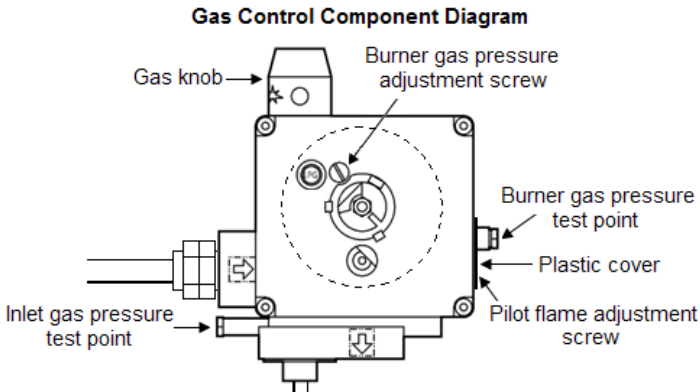

Note: Gas control shown with temperature adjustment dial (---) removed

To check inlet gas pressure:

1. Ensure all other gas appliances in the premises are operating (burners alight).
2. Ensure water heater is turned off and gas control is completely shut down (refer to “Shut Down Procedure” on page 8).
3. Remove screw from inlet gas pressure test point on gas control and attach manometer hose to test point.
4. Light the water heater and ensure burner is operating (refer to “Lighting Instructions” on page 6).
5. Take manometer reading with burner operating.
6. Turn off water heater by completely shutting down gas control (refer to “Shut Down Procedure” on page 8).
7. Remove manometer hose from inlet gas pressure test point and replace test point screw.
8. Test inlet gas pressure test point for leaks using a soapy water solution.
9. If inlet gas pressure is correct, light the water heater and ensure burner is operating (refer to “Lighting Instructions” on page 6). If inlet gas pressure is incorrect, contact Aquamax service.
10. Replace front access panel.

Testing & Adjusting Burner Gas Pressure

The burner gas pressure must be checked and adjusted (where applicable) as part of the commissioning procedure. The burner gas pressure should be 1.0 kPa for natural gas models and 2.7 kPa (-5%, +10% tolerance) for propane gas models with the burner operating (alight). Refer to “Gas Control Component Diagram” on page 31 for component location.

To check and adjust burner gas pressure:

1. Ensure water heater is turned off and gas control is completely shut down (refer to “Shut Down Procedure” on page 8).
2. Using a small flat bladed screwdriver, lever and remove the black plastic cover surrounding burner gas pressure test point on gas control.
3. Remove screw from burner gas pressure test point and attach manometer hose to test point.
4. Light the water heater and ensure burner is operating (refer to “Lighting Instructions” on page 6).

5. Take manometer reading with burner operating.

If reading is 1.0 kPa for natural gas models or 2.7 kPa (-5%, +10% tolerance) for propane gas models, the burner gas pressure is correct. Proceed directly to step 7.

If reading is not 1.0 kPa for natural gas models or 2.7 kPa (-5% +10% tolerance) for propane gas models, the burner gas pressure will require adjusting in which case proceed to step 6a for natural gas models or step 6b for propane gas models.

6. **a. Natural Gas Models**

- i. Remove temperature adjustment dial using a small flat bladed screwdriver; lever and pull dial away from gas control.
- ii. Using a small flat bladed screwdriver, rotate burner pressure adjustment screw (marked P.R.ADJ.) clockwise to increase or anticlockwise to decrease burner gas pressure until manometer reads 1.0 kPa. Proceed to step 7.

- b. Propane Gas Models**

- i. Burner gas pressure should be 2.7 kPa (-5% +10% tolerance) whilst burner is operating. If this value is not obtained, phone Aquamax service or their nearest Accredited Service Agent to arrange for an inspection. **Note:** The Propane gas control valve and regulator cannot be adjusted.
 - ii. Turn off water heater by completely shutting down gas control (refer to “Shut Down Procedure” on page 8).
 - iii. Remove manometer hose from burner gas pressure test point and replace test point screw.
 - iv. Replace front access panel. End of procedure.
7. Turn off water heater by completely shutting down gas control (refer to “Shut Down Procedure” on page 8).
 8. Remove manometer hose from burner gas pressure test point and replace test point screw.
 9. Light the water heater and ensure burner is operating (refer to “Lighting Instructions” on page 6).
 10. Test burner gas pressure test point for leaks using a soapy water solution.
 11. Replace black plastic cover surrounding burner gas test point by pushing back into position. For natural gas models, replace temperature adjustment dial.
 12. Replace front access panel.

Draining the Water Heater

 **Warning:** *Water discharged from the water heater during this procedure may be of a very high temperature. Wear personal protective equipment to reduce the risk of scalding.*

To drain the water heater:

1. Ensure water heater is turned off and gas control is completely shut down (refer to “Shut Down Procedure” on page 8).
2. Close cold water isolation valve on cold water line to water heater.
3. Close all hot water taps in premises.
4. Operate PTR valve lever for a period of five seconds to release pressure in water heater. **Note:** Operate lever gently and do not let lever snap back or you will damage relief valve seat.
5. Undo union at cold water inlet to water heater and attach a hose to water heater side of union. Run other end of hose to a drain.
6. Operate PTR valve lever until all water has drained from water heater. Operating PTR valve lever will let air into the water heater which will allow water to drain through hose.

Dimensions & Technical Data

G270VE Model – Without Mixing Valve

APPROVALS:

This unit complies with AS 3498
WaterMark Licence No. WMKA00200

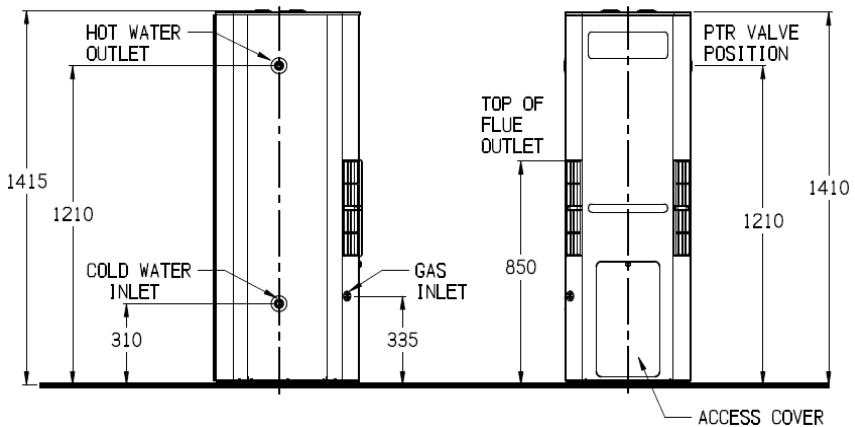
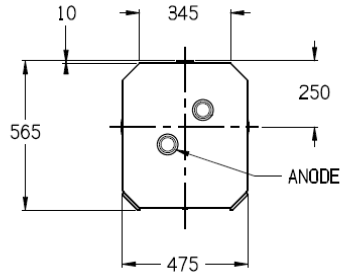

Storage capacity (L)		135	Connections	
Hot water delivery (L)		140	Cold water inlet	RP ³ / ₄ /20
Recovery rate *		135 L/Hr @ 45°C	Hot water outlet	RP ³ / ₄ /20
First hour capacity (L)		270	PTR valve	RP ¹ / ₂ /15
Mass (kg)	Empty	65	Gas inlet (flared compression)	¹ / ₂ /15
	Full	200	Condensate drain	On request
Max Supply Pressure			Gas Details	
With ECV (kPa)		960	Hourly consumption (MJ/hr)	30
Without ECV (kPa)		1120	Min supply pressure (kPa)	NG: 1.13 or LP: 2.75
ECV setting (kPa)		1200	Max supply pressure (kPa)	NG & LP: 3.5
PTR Valve (kPa)		1400	Burner pressure (kPa)	NG: 1.0 or P: 2.7

* Based on an inlet water temperature of 15°C.

Technical data is subject to change.

This page is intentionally blank

This page is intentionally blank

This page is intentionally blank

WARRANTY

AQUAMAX GAS DOMESTIC MAINS PRESSURE WATER STORAGE HEATER WARRANTY – AUSTRALIA ONLY-

1. THE AQUAMAX WARRANTY - GENERAL

- 1.1 This warranty is given by Aquamax Australia Pty Limited, ABN 37 138 189 689 of 463-467 Warrigal Road, Moorabbin Victoria.
- 1.2 Aquamax offer a trained and qualified service network who will repair or replace components at the address of the water heater subject to the terms of the Aquamax warranty. Aquamax Service, in addition can provide preventative maintenance and advice on the operation of your water heater. The Aquamax Service contact number is available 7 days a week on 1800 676 000 from 9am to 5pm, excluding public holidays (hours subject to change without notification).
- 1.3 For details about this warranty, you can contact us on 1800 676 000 or by email at service@aquamax.com.au (not for service bookings).
- 1.4 The terms of this warranty is set out in section 2 and apply to water heaters manufactured after 1st January 2012.
- 1.5 If a subsequent version of this warranty is published, the terms of that warranty will apply to water heaters manufactured after the date specified in the subsequent version.

2. TERMS OF AQUAMAX WARRANTY AND EXCLUSIONS TO IT

- 2.1 The decision of whether to repair or replace a faulty component is at Aquamax's sole discretion.
- 2.2 If you require a call out and we find that the fault is not covered by Aquamax warranty, you are responsible for our standard call out charge. If you wish to have the relevant component repaired or replaced by Aquamax, that service will be at your cost.
- 2.3 Where a failed component or cylinder is replaced under this warranty, the balance of the original warranty period will remain effective. The replacement does not carry a new Aquamax warranty.

- 2.4 Where the water heater is installed outside the boundaries of a metropolitan area as defined by Aquamax or further than 25 km from either a regional Aquamax branch office or an Accredited Aquamax Service Agent's office, the cost of transport, insurance and travelling between the nearest branch office or Aquamax Accredited Service Agent's office and the installed site shall be the owner's responsibility.
- 2.5 Where the water heater is installed in a position that does not allow safe or ready access, the cost of that access, including the cost of additional material handling and/or safety equipment, shall be the owner's responsibility. In other words, the cost of dismantling or removing cupboards, doors or walls and the cost of any special equipment to bring the water heater to floor or ground level or to a serviceable position is not covered by this warranty.
- 2.6 This warranty only applies to the original and genuine Aquamax water heater in its original installed location and any genuine Aquamax replacement parts.
- 2.7 The Aquamax warranty does not cover faults that are a result of:
- a. Accidental damage to the water heater or any component (for example: (i) Acts of God such as floods, storms, fires, lightning strikes and the like; and (ii) third party acts or omissions).
 - b. Misuse or abnormal use of the water heater.
 - c. Installation not in accordance with the Owner's Guide and Installation Instructions or with relevant statutory and local requirements in the State or Territory in which the water heater is installed.
 - d. Connection at any time to a water supply that does not comply with the water supply guidelines as outlined in the Owner's Guide and Installation Instructions.
 - e. Repairs, attempts to repair or modifications to the water heater by a person other than Aquamax Service or an Aquamax Accredited Service Agent.
 - f. Faulty plumbing or faulty gas supply.
 - g. Failure to maintain the water heater in accordance with the Owner's Guide and Installation Instructions.
 - h. Transport damage.
 - i. Fair wear and tear from adverse conditions (for example, corrosion)
 - j. Cosmetic defects.

- 2.8 Subject to any statutory provisions to the contrary, this warranty excludes any and all claims for damage to furniture, carpet, walls, foundations or any other consequential loss either directly or indirectly due to leakage from the water heater, or due to leakage from fittings and/or pipe work of metal, plastic or other materials caused by water temperature, workmanship or other modes of failure.
- 2.9 If the water heater is not sized to supply the hot water demand in accordance with the guidelines in the Aquamax water heater literature, any resultant fault will not be covered by Aquamax warranty.

3. WHAT IS COVERED BY AQUAMAX WARRANTY FOR THE WATER HEATERS DETAILED IN THIS DOCUMENT

- 3.1 Aquamax will repair or replace a faulty component of your water heater if it fails to operate in accordance with its specifications as follows:

What components are covered	The period in which the fault must appear in order to be covered	What coverage you receive
All components	Year 1	Repair and/or replacement of the faulty component, free of charge, including labour.
The cylinder (if the water heater is installed in a single-family domestic dwelling)	Year 2 to 5	Replacement cylinder, free of charge. Installation and repair labour costs are the responsibility of the owner.
The cylinder (if the water heater is <u>not</u> installed in a single-family domestic dwelling)	Year 1	Repair and/or replacement of the faulty component, free of charge, including labour.

4. ENTITLEMENT TO CLAIM UNDER THIS WARRANTY

- 4.1 To be entitled to make a claim under this warranty, you need to:
- a. Be the owner of the water heater or have consent of the owner to act on their behalf.
 - b. Contact Aquamax Service without undue delay after detection of the defect and, in any event, within the applicable warranty period.
- 4.2 You are not entitled to make a claim under this warranty if your water heater:
- a. Does not have its original serial numbers or rating label.
 - b. Is not installed in Australia.

5. HOW TO MAKE CLAIM UNDER THIS WARRANTY

- 5.1 If you wish to make a claim under this warranty, you need to:
- a. Contact Aquamax on 1800 676 000 and provide owner's details, address of the water heater, a contact number and date of installation of the water heater or if that's unavailable, the date of manufacture and serial number (from the rating label on the water heater).
 - b. Aquamax will arrange for the water heater to be tested and assessed on-site.
 - c. If Aquamax determines that you have a valid warranty claim, Aquamax will repair or replace the water heater in accordance with this warranty.
- 5.2 Any expenses incurred in the making of a claim under this warranty will be borne by you.

6. THE AUSTRALIAN CONSUMER LAW

- 6.1 Our goods come with guarantees that cannot be excluded under the Australian Consumer Law. You are entitled to a replacement or refund for a major failure and for compensation for any other reasonably foreseeable loss or damage. You are also entitled to have the goods repaired or replaced if the goods fail to be of acceptable quality and the failure does not amount to a major failure.
- 6.2 The Aquamax's warranty (set out above) is in addition to any rights and remedies that you may have under the Australian Consumer Law.

INSTALLER INFORMATION

DEAR INSTALLER,

Please provide the following information upon completion of the installation. This information should be provided to assist the customer in the event that a claim is made under the Aquamax warranty.

Plumber (Name & Company):

Plumber's licence number:

Compliance Certificate:

(if applicable in your state)

Installation date:

Model & serial number:

Water Heater date of manufacture:

AQUAMAX AUSTRALIA PTY. LTD

ABN 37 138 189 689

www.aquamax.com.au

FOR SERVICE TELEPHONE

1800 676 000

Revision Date: 06/12/2011

AQ0901022-G